

REPUBLIC OF CAMEROON  
Peace-Work-Fatherland  
.....  
NORTH-WEST REGIONAL ASSEMBLY  
.....  
REGIONAL EXECUTIVE COUNCIL  
.....  
PEACE-JUSTICE-UNITY-HARD WORK- SOLIDARITY  
.....



REPUBLIQUE DU CAMEROUN  
Paix-Travail-Patrie  
.....  
ASSEMBLEE REGIONALE DU NORD-OUEST  
.....  
CONSEIL EXECUTIF REGIONAL  
.....  
PAIX-JUSTICE-UNITE-TRAVAIL-SOLIDARITE  
.....

# OPEN NATIONAL INVITATION TO TENDER

\*\*\*\*\*

## TENDER FILE

\*\*\*\*\*

### PROJECT OWNER:

*THE PRESIDENT OF THE NORTH WEST REGIONAL ASSEMBLY*

### CONTRACTING AUTHORITY:

*THE PRESIDENT OF THE NORTH WEST REGIONAL ASSEMBLY*

### TENDER BOARD:

*NORTH WEST REGIONAL ASSEMBLY INTERNAL TENDERS BOARD (NWRAITB)*

TENDER FILE N° 031 /ONIT/NWRA/ITB/2026 OF 19 /MAR /2026  
FOR THE PHASE II CONSTRUCTION AND COMPLETION OF A  
THEATRE BLOCK AT NKWEN DISTRICT HOSPITAL (RELAUNCH)

AUTHORIZATION NO:

BUDGETARY HEAD:

\_\_\_\_\_  
2026 FINANCIAL YEAR  
\_\_\_\_\_

## TABLE OF CONTENTS

Document No. 1: Tender Notice.....	3
Document No. 2: General Regulations of the Invitation to Tender .....	12
Document No. 3: Special Regulations of the Invitation to Tender .....	28
Document No. 4: Special Administrative Conditions .....	37
Document No. 5: Special Technical Conditions .....	50
Document No. 6: Schedule of unit prices .....	57
Document No. 7: Bill of quantities and estimates.....	60
Document No. 8: The sub-detail of prices .....	63
Document No. 9: Model Contract.....	65
Document No. 10: Model documents to be used by bidders .....	70
Document No. 11: Justifications of preliminary studies .....	83
Document No. 12: List of banking establishments and financial bodies authorised to issue bonds for Public Contracts .....	85

# Document N<sup>o</sup>. 1

TENDER NOTICE

REPUBLIC OF CAMEROON  
Peace-Work-Fatherland  
.....  
NORTH-WEST REGIONAL ASSEMBLY  
.....  
REGIONAL EXECUTIVE ASSEMBLY  
.....  
PEACE-JUSTICE-UNITY-HARD WORK- SOLIDARITY  
.....



REPUBLIQUE DU CAMEROUN  
Paix-Travail-Patrie  
.....  
ASSEMBLEE REGIONALE DU NORD-OUEST  
.....  
CONSEIL EXECUTIF REGIONAL  
.....  
PAIX-JUSTICE-UNITE-TRAVAIL-SOLIDARITE  
.....

## TENDER NOTICE

OPEN NATIONAL INVITATION TO TENDER FILE N° 3 /ONIT/NWRA/ITB/2026 OF 9 / MAR / 2026  
2026 FOR THE PHASE II CONSTRUCTION AND COMPLETION OF A THEATRE BLOCK AT  
NKWEN DISTRICT HOSPITAL (RELAUNCH)

Financing: Public Investment Budget – 2026

### 1. Subject of the Invitation to Tender:

Within the framework of 2026 Public Investment Budget, The President of the North West Regional assembly, contracting authority, hereby launches an open national invitation to tender for the phase II construction and completion of a theatre block at Nkwen District Hospital

### 2. Nature of works:

Works to be done consists of  
100 : PRELIMINARY WORKS  
200: ELEVATION OF FIRST FLOOR  
300 : CARPENTARY AND JOINERY (ROOFING)  
400 : SECTION 14: PLUMBING SANITARY INSTALLATION  
500 : WOODEN AND METALLIC WORKS  
600 : WINDOWS  
700 : ELECTRICAL WORKS  
800 : PLASTERING AND RENDERING  
900 : FLOORING/TILING  
1000: PAINTING  
1100: EXTERNAL WORKS

### 3. Execution deadline

The maximum deadline provided by the Contracting Authority for the execution of the works subject of this Invitation to tender is **Four (04) calendar Months**.

### 4. Lots: this project is in a single lot as shown below

LOT No.	DIVISION	LOCALITY	PROJECT
01	MEZAM	NKWEN	phase II construction and completion of a theatre block at Nkwen District Hospital

### 5. Estimated Cost

The estimated cost of the projects after preliminary studies is as follows:

LOT No.	DIVISION	LOCALITY	PROJECT	AMOUNT
01	MEZAM	NKWEN	phase II construction and completion of a theatre block at Nkwen District Hospital	98,000,000

**6. Participation and origin**

Participation in this Invitation to tender is opened under the same conditions to all Cameroonian companies and business persons that have proven experience in the field of building construction and provided they are in compliance with the Cameroonian laws.

**7. Financing**

Works which are the subject of this Invitation to Tender shall be financed by the 2026 Public Investment Budget assigned to the North-West Regional Assembly.

**8. Bid bond**

The bidder must include in his administrative documents, a bid bond issued by a first-rate financial establishment approved by the Ministry in charge of Finance and whose list is found in document N°. 12 of the Tender File, of an amount, (See table below) valid for thirty (30) days beyond the date of validity of bids.

LOT No.	PROJECT	AMOUNT	AMOUNT OF BID BOND	TENDER FILE FEE
01	phase II construction and completion of a theatre block at Nkwen District Hospital	98,000,000	1,960,000	98,600

**9. Consultation of Tender File:**

The file may be consulted during working hours at the office of the Director of General Affairs at the North West Regional Assembly (Annex Building of Block "A") Tel N° 2 33 36 00 92 or online using the address; [www.marchespublics.cm](http://www.marchespublics.cm), as soon as this notice is published.

**10. Acquisition of Tender File:**

The file may be obtained from the office of the Director of General Affairs at the North West Regional Assembly, Tel N°2 33 36 00 92 or online using the address: [www.marchespublics.cm](http://www.marchespublics.cm), as soon as this notice is published against payment of the sum of **Ninety Eight thousand Six hundred (98,600) Francs CFA**, into the North West Regional Assembly Treasury (Block B), representing the cost of purchasing the Tender File.

**11. Submission of bids:**

The method of submission shall be online.

The Tender must be submitted by the Tenderer on the COLEPS Platform not later than 7/12/2026 at 10:00am. A backup copy of the Tender saved in a USB key or a CD/DVD must be sent in a sealed envelope with a clear and legible indication "backup copy" within the time limit bearing the label:

**OPEN NATIONAL INVITATION TO TENDER FILE**  
No 31 /ONIT/NWRA/ITB/2026 OF 19 /MAY/ 2026, FOR THE PHASE II CONSTRUCTION AND COMPLETION OF A THEATRE BLOCK AT NKWEN DISTRICT HOSPITAL (RELAUNCH)  
*"To be opened only during the bid-opening session"*

**File Size and Format:**

The maximum size of the documents that will be uploaded on the platform and constituting the bidder's offer shall be;

- 5 Mb for Administrative offers;
- 15 Mb for the Technical offers;
- 5 Mb for the financial offers.

Supported formats shall include:

- PDF formats for texts documents;
- JPEG formats for images.

The Tenderer shall use a compression software to reduce the size of the file to be submitted.

**12. Admissibility of bids**

Under penalty of being rejected, only originals or certified true copies signed by the issuing service or administrative authorities (Governor, Senior Divisional Officer, Divisional Officers....) must imperatively be produced in accordance with the Special Regulations of the Invitation to Tender.

They must obligatorily not be older than three (3) months preceding the date of submission of bids or may be established after the signature of the tender notice

Any bid not in compliance with the prescriptions of the Tender File shall be rejected. This refers especially to the absence of a bid bond issued by a first-rate bank approved by the Minister in charge of Finance

### **13. Opening of bids:**

The bids shall be opened in a single phase. The opening of the administrative documents, the Technical and Financial offers will take place on the    /    /2026 at **11.00 am** local time, in the conference hall of the North West Regional Assembly Internal Tenders' Board, by its competent members. Only bidders may attend or be represented by duly mandated persons of their choice and having a good knowledge of their files.

### **14. Evaluation criteria**

The bids shall be evaluated according to the main criteria as follows:

#### **A. Eliminatory criteria**

1. Absence or non-conformity of an element in the administrative file non regularized within 48 hours after opening of bids
2. Execution deadline higher than prescribed in the Tender File;
3. False declaration or falsified documents;
4. Absence or insufficient bid bond;
5. A bid with the external envelope carrying a sign leading to the identification of the bidder;
6. Incomplete financial file;
7. Non respect of 75% of essential criteria;
8. Suspended by MINMAP for 2026.
9. Average annual turnover of at least the tendering amount (Average annual turnover calculated as total certified payments received for contracts in progress or completed, within the last five (5) years (from 2021). This should be justified by copies of past contracts (completed or ongoing). Final reception minutes for all completed contracts before 2026 and provisional reception minutes for contracts completed in 2025 should be presented.
10. Failure to provide a backup copy of offers saved in a USB key or a CD/DVD on time;
11. Failure to comply with the format of file type and size for online submission;
12. Failure to present a CDEC receipt or proof of deposit of the amount of the bid bond requested into the Deposit and Guarantee Fund;
13. Failure to present a certificate of categorization or receipt of deposit of file for categorisation of the enterprise in the "Building and General Equipment" sub-sector of activities.

#### **B. Essential criteria**

- 1- General presentation of the Tender Files;
- 2- Financial capacity;
- 3- References of the company in similar achievements visa by the competent authority;
- 4- Quality of the personnel;
- 5- Technical organization of the works;
- 6- Safety measures on the site;
- 7- Logistics;
- 8- Attestation of site visit duly signed on honour by the bidder and report of site visit with pictures;
- 9- Special Technical Clauses initialed in all the pages, signed and dated at the last page;
- 10- Special Administrative Clauses completed and initialed in all the pages, signed and dated at the last page.

### **15. Award**

The evaluation will be done in a binary way (yes) or (no) with an acceptable minimum score of 75% of the essential criteria taken in account.

The Contract will be awarded to the bidder who would have proposed the offer with the lowest amount, in conformity with the regulations of the Tender Documents and having satisfied to 100% of the eliminatory criteria and at least 75% of the essential criteria.

**16. Validity of bids**

Bidders will remain committed to their offers for Ninety (90) days from the deadline set for the submission of tenders.

**17. Complementary information**

Complementary technical information may be obtained during working hours from the office of the Director of General Affairs, North West Assembly Building, Block "A". (Tel N°2 33 36 00 92).

Done at Bamenda on 19 MARS 2026

**THE PRESIDENT OF THE REGIONAL ASSEMBLY  
(Contracting Authority)**

*Copies:*

- ARMP BAMENDA
- RD/MINMAP/NW
- Chairperson of TB/NWRA
- Notice Board
- File/archive





## AVIS D'APPEL D'OFFRES PAR PROCEDURE D'URGENCE

### APPEL D'OFFRE NATIONAL OUVERT

-N° 31/ONIT/NWRA/NWRAITB/2026 DU 9 2026 POUR LA CONSTRUCTION ET  
L'ACHÈVEMENT DE LA PHASE II D'UN BLOC THÉÂTRE À L'HÔPITAL DE DISTRICT DE  
NKWEN (RELANCER)

Financement : Budget d'Investissement Public 2026

#### 1. Objet de l'Appel d'Offre

Dans le cadre de l'exercice budgétaire 2026, le Président de l'Assemblée Régionale du Nord-Ouest, Autorité Contractante lance un Appel d'Offres National Ouvert **POUR LA CONSTRUCTION ET L'ACHÈVEMENT DE LA PHASE II D'UN BLOC THÉÂTRE À L'HÔPITAL DE DISTRICT DE NKWEN (RELANCER)**

#### 2. Consistance des travaux

Les travaux comprennent notamment :

- 100 : TRAVAUX PRÉLIMINAIRES
- 200 : ÉLÉVATION DU PREMIER ÉTAGE
- 300 : CHARPENTERIE ET MENUISERIE (COUVERTURE)
- 400 : SECTION 14 : INSTALLATION SANITAIRE DE PLOMBERIE
- 500 : TRAVAUX EN BOIS ET MÉTAL
- 600 : FENÊTRES
- 700 : TRAVAUX ÉLECTRIQUES
- 800 : PLAQUISTERIE ET ENDUIT
- 900 : REVÊTEMENT DE SOL / CARRELAGE
- 1000 : PEINTURE
- 1100 : TRAVAUX EXTÉRIEURS

#### 3. Délais d'exécution

Le délai maximum prévu le Maître d'Ouvrage Délégué pour la réalisation des travaux objet du présent appel d'offres est de **Quatre (04) Mois par lot.**

#### 4. Allotissement

Le travail est ci-après défini à un lot :

LOT No.	DIVISION	LOCALITÉ	PROJET
01	MEZAM	NKWEN	District

#### 5. Coût de prévisionnel

Le coût prévisionnel de l'opération à l'issue des études préalables est de;

LOT No.	DEPARTMEN T	LOCALITÉ	PROJET	MONTAN
01	MEZAM	NKWEN	District	98,000,000

#### 6. Participation et origine

La participation à cette consultation est ouverte aux entreprises de droit camerounais.

#### 7. Financement

Les travaux objet du présent appel d'offres sont financés par le Budget d'Investissement Publics du Cameroun de l'exercice 2026.

#### 8. Cautionnement provisoire

Chaque soumissionnaire doit joindre à ses pièces administratives, une caution de soumission établie par une banque de premier ordre agréée par le Ministère chargé des finances et dont la liste figure dans la pièce 12 du DAO, d'un montant, (voir tableur) valable pendant trente (30) jours au-delà de la date originale de validité des offres.

LOT No.	PROJET	MONTANT	MONTANT DE LA CAUTION DE SOUMISSION	FRAIS DE DOSSIER D'APPEL D'OFFRES
01	Construction et achèvement de la phase II d'un bloc de théâtre à l'hôpital du district de Nkwen	98,000,000	1,960,000	98,600

#### 9. Consultation du Dossier d'Appel d'Offres

Le Dossier d'Appel d'Offres peut être consulté et obtenu aux heures ouvrables au bureau du Directeur des Affaires Générales de l'Assemblée Régionale du Nord-Ouest (Tel N° 2 33 36 00 92) ou en ligne à l'adresse: [www.marchespublics.cm](http://www.marchespublics.cm) dès Publication du présent avis.

#### 10. Acquisition du Dossier d'Appel d'Offres

Le dossier peut être obtenu aux heures ouvrables après Publication du présent avis au bureau de l'autorité contractant (Tel N° 2 33 36 00 92) ou en ligne à l'adresse: [www.marchespublics.cm](http://www.marchespublics.cm) contre présentation d'une quittance de versement au Trésor de l'Assemblée Régionale du Nord-Ouest de la somme non remboursable de 98,600 (quatre-vingt-dix-huit millions six cents) Francs CFA.

#### 11. Remise des offres

La méthode de remise doit être en ligne

L'offre devra être déposée par le soumissionnaire sur la plateforme COLEPS au plus tard de le 22 /2026 à 10 h 00. Une copie de sauvegarde de l'offre sauvegardée sur une clé USB ou un CD/DVD devra être envoyée dans une enveloppe fermée avec la mention claire et lisible « copie de sauvegarde » portant le libellé dans le délai imparti.

APPEL D'OFFRES NATIONAL OUVERT  
N° 03 / AONO/ARNO/ARNOCIPM/2026 DU 19 MARS 2026

POUR LA CONSTRUCTION ET ACHÈVEMENT DE LA PHASE II D'UN BLOC DE THEATRE A L'HOPITAL DU DISTRICT DE NKWEN (RELANCER)

Taille et format du fichier :

Pour les enchères en ligne, la taille maximale de documents qui seront téléchargés sur la plateforme et constituant l'offre du soumissionnaire sera de ;

- 5 Mo pour les offres administratives,
- 15Mo pour les offres Techniques,
- 5 Mo pour les offres financements.

Les formats pris en charge doivent inclure :

- Formats PDF pour documents textes,
- Formats JPEG pour les images.

Le soumissionnaire devra utiliser un logiciel de compression pour réduire la taille du fichier à soumettre.

#### 12. Recevabilité des offres

Sous peine de rejet, les pièces du dossier administratif requises doivent être produites en originaux ou en copies certifiées conformes par le service émetteur ou une autorité administrative (Gouverneur, Préfet, Sous-préfet,...), conformément aux stipulations du Règlement Particulier de l'Appel d'Offres.

Elles doivent dater de moins de trois (03) mois précédant la date originale de dépôt des offres ou avoir été établies postérieurement à la date de signature de l'Avis d'Appel d'Offres.

Toute offre incomplète conformément aux prescriptions du Dossier d'Appel d'Offres sera déclarée irrecevable. Notamment l'absence de la caution de soumission délivrée par une banque de premier ordre agréée par le Ministère chargé des Finances.

### 13. Ouverture des plis

L'ouverture des plis se fera en un temps. L'ouverture des pièces administratives et des offres techniques et financières aura lieu le 7 /2026 à **11h 00**, heure locale, dans la salle de conférence du Président de l'Assemblée Régionale du Nord-Ouest siégeant en présence des soumissionnaires ou de leurs représentants dûment mandatés et ayant une parfaite connaissance du dossier.

### 14. Critères d'évaluation

Les offres seront évaluées selon les principaux critères suivants :

#### A - Critères éliminatoires

Il s'agit notamment:

- 1- Absence ou non-conformité de document administratif qui ne peuvent pas se régulariser pendant quarante-huit heures après l'ouverture des offres
- 2- Délai d'exécution supérieur à celui prescrit dans le DAO ;
- 3- Fausses déclarations ou pièces falsifiées ;
- 4- Absence ou insuffisance de la caution provisoire de soumission ;
- 5- Offres dont l'enveloppe extérieure porte des mentions permettant de reconnaître le Soumissionnaire ;
- 6- Offres financière incomplète ;
- 7- Le non-respect de **75%** des critères essentiels ;
- 8- Suspendu par le MINMAP en 2026;
- 9- Chiffre d'affaires annuel moyen au moins égal au montant de l'offre (chiffre d'affaires annuel moyenne calculée comme le total des paiements certifiés reçus pour les contrats en cours ou achevés, au cours du dernier cinq (5) ans (à partir de 2021) à justifier par des copies des contrats passés (achevés ou en cours. Procès-verbal de réception définitif pour tous les marchés terminés avant 2026 et procès-verbal de réception provisoire pour les contrats terminés en 2025 à présenter)
- 10- Défaut de fournir une copie de sauvegarde de l'offre sauvegardée sur une clé USB ou un CD/DVD à temps.
- 11- Défaut de se conformer au format du type de fichier et de la taille pour la soumission en ligne ;
13. Défaut de présenter un reçu du CDEC ou une preuve de dépôt du montant de la caution de soumission exigée auprès du Fonds de dépôt et de garantie;
14. Défaut de présenter un certificat de catégorisation ou un reçu de dépôt du dossier de catégorisation de l'entreprise dans le sous-secteur d'activité « Bâtiment et équipement général ».

#### B - Critères essentiels

Les critères relatifs à la qualification des candidats porteront à titre indicatif sur :

- 1- Présentation générale de l'offre ;
- 2- Capacité financière ;
- 3- Références de l'entreprise dans les réalisations similaires ;
- 4- Qualité du personnel ;
- 5- Organisation technique des travaux ;
- 6- Sécurité au chantier ;
- 7- Moyens logistiques ;
- 8- Attestations de visite de site signée sur l'honneur par le soumissionnaire et rapport de visite du site avec photos ;
- 9- Cahier des Clauses Techniques Particulières paraphé à chaque page, signé et daté à la dernière page ;
- 10- Cahier des Clauses Administratives Particulières complété et paraphé à chaque page.

signe et date à la dernière page.

Les critères essentiels sont soumis à des minima dont le détail est donné dans le Règlement Particulier de l'Appel d'Offres (RPAO).

#### 15. Attribution

Cette évaluation se fera de manière purement positive (oui) ou négative (non) avec un minimum acceptable d'au moins 75% de l'ensemble des critères essentiels pris en compte.

Le marché sera attribué au soumissionnaire qui aura proposé l'offre le moins disante, conforme pour l'essentiel aux prescriptions du Dossier d'Appel d'Offres, ayant satisfait à 100% des critères éliminatoires et au moins 75% des critères essentiels. Un enchérisseur peut soumissionner pour plus d'un lot mais ne peut se voir attribuer qu'un seul lot.

#### 16. Durée de validité des offres

Les soumissionnaires restent engagés par leur offre pendant 90 jours à partir de la date limite fixée pour la remise des offres.

#### 17. Renseignements complémentaires

Les renseignements complémentaires d'ordre technique peuvent être obtenus auprès de bureau du Directeur des Affaires Générales (Tel N° 2 33 36 00 92).

Fait à Bamenda, le 19 MARS 2026

Le Président de l'Assemblée Régionale du Nord Ouest  
(Autorité Contractante)

#### Copie :

- ARMP
- DR/MINMAP/NW
- Présidents CIPM/NWRA
- Affichage
- Chrono/archive



*Fobuzshi Ingwalo III*  
President North West Regional  
Executive Council

**Document N°. 2**  
**GENERAL REGULATIONS OF THE**  
**INVITATION TO TENDER**

## TABLE OF CONTENTS

<b>A. General</b>	
Article 1: Scope of the tender.....	
Article 2: Financing.....	
Article 3: Fraud and corruption.....	
Article 4: Candidates admitted to compete.....	
Article 5: Building materials, materials, supplies, equipment and authorised services...	
Article 6: Qualification of the bidder.....	
Article 7: Visit of work site .....	
<b>B. Tender File.....</b>	
Article 8: Content of Tender File.....	
Article 9: Clarifications on Tender File and complaints .....	
Article 10: Modification of the Tender File.....	
<b>C. Preparation of Bids</b>	
Article 11: Tender fees.....	
Article 12: Language of bid.....	
Article 13: Constituent documents of the bid.....	
Article 14: Amount of bid.....	
Article 15: Currency of bid and payment.....	
Article 16: Validity of bids.....	
Article 17: Bid bond.....	
Article 18: Varying proposals by bidders.....	
Article 19: Preparatory meeting to the establishment of bids.....	
Article 20: Form and signature of bids.....	
<b>D. Submission of bids.....</b>	
Article 21: Sealing and marking of bids.....	
Article 22: Date and time-limit for submission of bids.....	
Article 23: Out of time-limit bids.....	
Article 24: Modification, substitution and withdrawal of bids.....	
<b>E. Opening and evaluation of bids .....</b>	
Article 25: Opening of bids.....	
Article 26: Confidential nature of the procedure.....	
Article 27: Clarifications on the bid and contact with Contracting Authority.....	
Article 28: Determination of their compliance.....	
Article 29: Qualification of the bidder.....	
Article 30: Correction of errors.....	
Article 31: Conversion into a single currency.....	
Article 32: Evaluation of financial bids.....	
Article 33: National preference.....	
<b>F. Award of the Contract.....</b>	
Article 34: Award.....	
Article 35: Right of the Contracting Authority to declare an Invitation to Tender unsuccessful or to cancel a procedure.....	
Article 36: Notification of the award of the Contract.....	
Article 37: Signature of the Contract.....	
Article 38: Final bond.....	

## GENERAL RULES OF THE INVITATION TO TENDER

### A. GENERAL

#### Article 1: Scope of the tender

The Contracting Authority, The President of the North West Regional Assembly hereby launches an Open National Invitation to Tender N°     /ONIT/NWRA/ITB/2026 of    /    /2026 FOR THE PHASE II CONSTRUCTION AND COMPLETION OF A THEATRE BLOCK AT NKWEN DISTRICT HOSPITAL (RELAUNCH)

1.2 The bidder retained or the preferred bidder must complete the works within the time- limit indicated in the Special Regulations which runs from the date of notification of the Administrative Order.

1.2 In this Tender File, the term “day” means a calendar day.

#### Article 2: Financing

The source of financing of the works forming the subject of this Invitation to Tender shall be specified in the Special Regulations.

#### Article 3: Fraud and corruption

3.1 The Contracting Authority requires of bidders and Contractors the strict respect of rules of professional ethics during the award and execution of Public Contracts. By virtue of this principle:

a) The following definitions shall be admitted:

- i) Shall be guilty of “corruption” whoever offers, gives, requests or accepts any advantage in view of influencing the action of a Public official during the award or execution of a Contract;
- ii) Is involved in “fraudulent manoeuvres” whoever deforms or distorts facts in order to influence the award or execution of a Contract;
- iii) “Collusive practices” shall mean any form of agreement between two or among several bidders (whether the Contracting Authority is aware or not) aimed at artificially maintaining the prices of bids at levels not corresponding to those resulting from competition;
- iv) “Coercive practices” shall mean any form of harm against persons or their property or threats against them in order to influence their action during the award or execution of a Contract.

b) Any proposed award shall be rejected if it is proved that the proposed preferred bidder is directly or through an intermediary, guilty of corruption or is involved in fraudulent manoeuvres, collusive or coercive practices for the award of this Contract.

3.2 The Minister Delegate at the Presidency in charge of Public Contracts may, as a precaution, take a decision of exclusion from bidding for a period not exceeding two (2) years against any bidder found guilty of influence peddling, of conflicts of interest, insider trading, fraud, corruption or production of non-genuine documents in the bid, without prejudice to criminal proceedings that may be brought against him

#### Article 4: Candidates are allowed to compete

4.1 If the Invitation to Tender is opened, consultation is addressed to all candidates retained after a pre-qualification procedure.

4.2 Generally, the Invitation to Tender is addressed to all entrepreneurs, subject to the following provisions:

- (a) A bidder (including all members of a group of enterprises and all sub-Contractors to the bidder) must be from an eligible country, in accordance with the funding agreement.

- (b) A bidder (including all members of a group of enterprises and all sub-Contractors to the bidder) must not be in a situation of conflict of interest, subject to disqualification. A bidder shall be judged to be in a situation of conflict of interest if he:
  - i) Is or was associated in the past with an enterprise (or a subsidiary of this enterprise) which provided consultancy services for the conception, preparation of specifications and other documents used within the scope of Contracts awarded for this Invitation to Tender; or
  - ii) Presents more than one bid within the context of Invitation to Tender, except authorised variants according to article 17, where need be; meanwhile, this does not prevent the participation of sub-Contractors in more than one bid.
  - iii) The Contracting Authority or Project Owner has financial interests in the capital in a way as to compromise the transparency of the procedures of award of Public Contracts.
- (c) The bidder must not have been excluded from bidding for Public Contracts.
- (d) A Cameroonian Public enterprise may participate in the consultation if it can demonstrate that it is
  - (i) legally and financially autonomous, (ii) managed according to commercial laws and (iii) not under the direct supervisory authority of the Contracting Authority or Project Owner.

**Article 5: Building materials, materials, supplies, equipment and authorised services**

- 5.1 Building materials, the Contractor's materials, supplies, equipment and services forming the subject of this Contract must originate from countries meeting the criteria of origin defined in the Special Regulations of the Invitation to Tender and all expenditure done within the context of the Contract shall be limited to the said building materials, materials, supplies, equipment and services.
- 5.2 Within the meaning of this 5.1 above, the term "originate" shall designate the place where the goods are extracted, cultivated, produced, manufactured and from where the services originate.

**Article 6: Qualification of bidder**

6.1 As an integral part of their bid, bidders must:

- (a) submit a power of attorney making the signatory of the bid bound by the bid; and
- (b) provide all information (complete or update information included in their request for pre-qualification which may have changed in the case where the candidates took part in pre-qualification) requested of bidders in the Special Regulations of the Invitation to Tender, in order to establish their qualification to execute the Contract.

Where necessary, bidders should provide information relating to the following points:

- (i) The production of certified balance sheets and recent turnovers;
  - (ii) Access to a line of credit or availability of other financial resources;
  - (iii) Orders acquired and Contracts awarded;
  - (iv) Pending litigations;
  - (v) Availability of indispensable equipment.
- 6.2 Bids presented by two or more associated undertakings (joint-Contracting) must satisfy the following conditions:
- (a) The bid must include all the information listed in article 6(1) above. The Special Regulations must indicate the information to be furnished by the group and that to be furnished by each member of the group;
  - (b) The bid and the Contract must be signed in a way that is binding on all members of the group;
  - (c) The nature of the group (joint or several) must be specified in the Special Regulations and justified with the production of a joint venture agreement in due form;

- (d) The member of the group designated as the representative will represent all the undertakings vis à vis the Project Owner and Contracting Authority with regard to the execution of the Contract;
- (e) In case of joint co-Contracting, the co-Contractors shall share the sums which are paid by the Project Owner into a single account. On the other hand, each undertaking is paid into its own account by the Project Owner where it is joint co-Contracting.

6.3 Bidders must equally present sufficiently detailed proposals to demonstrate that they comply with the technical specifications and execution time-limits set in the Special Regulations of the Invitation to Tender.

6.4 Bidders requesting to benefit from the margin of preference must furnish all the necessary information to prove that they satisfy the eligibility criteria set in article 33 of the General Regulations of the Invitation to Tender.

#### **Article 7: Visit of works site**

7.1 The bidder is advised to visit and inspect the site and its environs and obtain by himself and under his own responsibility, all the information which may be necessary for the preparation of the bid and the execution of the works. The related cost of the visit of the site shall be borne by the bidder.

7.2 The Project Owner shall authorise the bidder and his employees or agents to enter the premises and the land for the said visit but only on the express condition that the bidder, his employees and agents free the Project Owner, his employees and agents of any responsibility that may ensue and indemnify them if necessary and that they shall remain responsible for any deadly or corporal accident, loss or material damages, costs and fees incurred from this visit.

7.3 The Project Owner may organise a visit of the site of the works during the preparatory meeting to establishing the bids mentioned in article 19 of the General Regulations of the Invitation to Tender.

## **B. TENDER FILE**

#### **Article 8: Content of Tender File**

8.1 The Tender File describes the works forming the subject of the Contract, sets the consultation procedure of Contractors and specifies the terms of the Contract. Besides the addendum (addenda) published in accordance with article 10 of the General Regulations of the Invitation to Tender, it includes the following documents:

- Document No. 1. The Tender Notice;
- Document No. 2. The General Regulations of the Invitation to Tender;
- Document No. 3. The Special Regulations of the Invitation to Tender;
- Document No. 4. The Special Administrative Conditions;
- Document No. 5. The Special Technical Conditions;
- Document No. 6. The schedule of unit prices;
- Document No. 7. The bill of quantities and estimates;
- Document No. 8. The sub details of unit prices;
- Document No. 9. Model documents of the Contract:
  - a. The execution schedule;
  - b. Model of forms presenting the equipment, personnel and references;
  - c. Model bidding letter;
  - d. Model bid bond;
  - e. Model final bond;
  - f. Model of bond of start-off advance;
  - g. Model of guarantee in replacement of the retention fund;
  - h. Model Contract;
- Document N<sup>o</sup>. 10. Models to be used by bidders;
  - a. Model Contract;

Document N<sup>o</sup>. 11. Justifications of preliminary studies; to be filled by the Project Owner or Delegated Project Owner;

Document N<sup>o</sup>. 12. List of first grade banking establishments or financial institutions approved by the Minister in charge of Finance authorised to issue bonds for Public Contracts to be inserted by the Contracting Authority.

8.2 The bidder must examine all the regulations, forms, conditions and specifications contained in the Tender File. It is up to him to furnish all the information requested and prepare a bid in compliance with all aspects of the said file.

#### **Article 9: Clarifications on the Tender File and complaints**

9.1 Any bidder who wants to obtain clarifications on the Tender File may request them from the Contracting Authority in writing or by electronic mail (fax or e-mail) at the Contracting Authority's address indicated in the Special Regulations of the Invitation to Tender and send a copy to the Project Owner. The Contracting Authority replies in writing to any request for clarification received at least fourteen (14) days prior to the deadline for the submission of bids.

A copy of the Contracting Authority's response, indicating the question posed but not mentioning the author, is addressed to all bidders who bought the Tender File.

9.2 Between the Publication of the tender notice including the pre-qualification phase of candidates and the opening of bids, any bidder who feels aggrieved in the Public Contracts award procedure may lodge a complaint to the Minister in charge of Public Contracts.

9.3 A copy of the complaint should be addressed to the Contracting Authority and to the body in charge of the Regulation of Public Contracts and the chairperson of the Tenders Board.

9.4 The Contracting Authority has five (5) days to react. A copy of the reaction shall be forwarded to MINMAP and the body in charge of the regulation of Public Contracts.

#### **Article 10: Amendment of the Tender File**

10.1 The Contracting Authority may at any moment, prior to the deadline for the submission of bids and for any reason, be it at his initiative or in reply to a request for clarification formulated by a bidder, amend the Tender File by publishing an addendum.

10.2 Any published addendum shall be an integral part of the Tender File, in accordance with article 8.1 of the General Regulations of the Invitation to Tender and must be communicated in writing or made known by a traceable means to all bidders who bought the Tender File.

10.3 In order to give bidders sufficient time to take account of the addendum in the preparation of their bids, the Contracting Authority may postpone as is necessary, the deadline for the submission of bids, in accordance with provisions of article 22 of the General Regulations of the Invitation to Tender.

## **C PREPARATION OF BIDS**

#### **Article 11: Tender costs**

The candidate shall bear the costs related to the preparation and presentation of his bid and the Contracting Authority and the Project Owner shall in no case be responsible for these costs nor pay for them whatever the evolution or outcome of the Invitation to Tender procedure.

#### **Article 12: Language of bid**

The bid as well as any correspondence and any document exchanged between the bidder and the Contracting Authority shall be written in English or French. Complementary documents and the forms provided by the bidder may be written in another language on condition that a precise translation into either English or French of the passages concerning the bid is included; in which case for reasons of interpretation, the translation shall be considered to be authentic.

### **Article 13: Constituent documents of the bid**

13.1 The bid presented by the bidder shall include the documents detailed in the Special Regulations of the Invitation to Tender, duly filled and put together in three volumes:

#### **a. Volume 1: Administrative file**

It includes:

- i) all documents attesting that the bidder:
  - has subscribed to all declarations provided for by the laws and regulations in force;
  - paid all taxes, duties, contributions, fees or deductions of whatever nature;
  - is not winding up or bankrupt;
  - is not the subject of an exclusion order or forfeiture provided for by the law in force;
- ii) The bid bond established in accordance with the provisions of article 17 of the General Regulations of the Invitation to Tender;
- iii) the written confirmation empowering the signatory of the bid to commit the bidder, in accordance with the provisions of article 6(1) the General Regulations of Invitation to Tender.

#### **b. Volume 2: Technical bid**

##### **b.1 Information on qualifications**

The Special Regulations list the documents to be furnished by bidders to justify the qualification criteria mentioned in article 6(1) of the Special Regulations of the Invitation to Tender.

##### **b.2 Methodology**

The Special Conditions of the Invitation to Tender specifies the constituent elements of the technical bid of the bidders especially: a methodological statement on an analysis of the works and specifying the organisation and programme which the bidder intends to put in place or use to execute the works (installations, schedule, Quality Assurance Plan (QAP), sub-Contracting, attestation of visit of the site, where necessary, etc).

##### **b.3 Proof of acceptance of conditions of the Contract**

The bidder shall submit duly initialled copies of the administrative and technical documents relating to the Contract, namely:

1. The Special Administrative Conditions (SAC);
2. The Special Technical Conditions (STC).

##### **b.4 Commentaries (optional)**

A commentary on the technical choices of the project and possible proposals.

#### **c. Volume 3: Financial bid**

The Special Regulations specify the elements that will help in justifying the cost of the works, namely:

1. The signed and dated original bid prepared according to the attached model, stamped at the prevailing rate;
2. The duly filled Unit Price schedule;
3. The duly filled detailed estimates;
4. The sub-details of prices and/or breakdown of all-in prices;
5. The projected schedule of payments, where need be.

In this regard, the bidders will use the documents and models provided in the Tender File, subject to the provisions of article 17(2) of the General Regulations of the Invitation to Tender concerning the other possible forms of guarantees.

- 13.2 If in accordance with the provisions of the Special Regulations of the Invitation to Tender, the bidders present bids for several lots of the same Invitation to Tender, they could indicate rebates offered in case of award of more than one lot.

**Article 14: Bid price**

- 14.1 Except otherwise stated in the Tender File, the amount of the Contract shall cover all the works described in article 1.1 of the General Regulations of the Invitation to Tender, on the basis of the price schedule and the detailed bill of quantities and estimates presented by the bidder.
- 14.2 The bidder shall fill the unit prices and totals of all items on the schedule and bill of quantities and estimates.
- 14.3 Subject to contrary provisions provided for in the Special Regulations and in the Special Administrative Conditions, all dues, taxes and fees payable by the bidder on grounds of the Contract or on any other ground, thirty (30) days prior to the submission of the bids, shall be included in the prices and in the total amount of the bid presented by the bidder.
- 14.4 If a price revision/updating clause is provided for in the Contract, the date of establishment of the initial price, as well as the price revision/updating conditions for the said price must be specified. This is with the understanding that any Contract of duration less than one (1) year shall not be subject to price revision.
- 14.5 All unit prices must be justified by sub-details established in accordance with the structure proposed in document 8 of the Tender File.

**Article 15: Currency of bid and payment**

- 15.1 In case of international invitations to tender, the currencies of the bid shall follow the provisions of either Option A or Option B below, the applicable option being that retained in the Special Regulations of the Invitation to Tender.

**15.2 Option A:** The amount of the bid shall be entirely made in the national currency.

The amount of the bid, unit prices of the price schedule and the prices of the bill of quantities and estimates are completely made in CFA francs in the following manner:

- a) Prices shall be entirely drawn in the national currency. The bidder who intends to commit expenditures in other currencies for the execution of the works shall indicate in the annex to the bid the percentage(s) of the amount of the bid necessary to cover the needs in foreign currencies, without exceeding the maximum of the three currencies of member countries of the funding institution of the Contract.
- b) The exchange rates used by the bidder to convert his bid into the national currency shall be specified by the bidder in an annex to the bid in compliance with the specifications of the Special Regulations. These rates shall be applied for any payment within the framework of the Contract so that the retained bidder does not bear any change in the exchange rate.

**15.3 Option B:** The amount of the bid shall be directly made in the national and foreign currency at the rates fixed in the Special Regulations.

The bidder shall draw the unit prices of the price schedule and the prices of the bill of quantities and estimates in the following manner:

- (a) The prices of inputs necessary for the works which the bidder intends to procure in the Contracting Authority's country shall be in currency of the Contracting Authority's country specified in the Special Regulations and called "national currency";
- (a) The prices of inputs necessary for works which bidder intends to procure out of the Contracting Authority's country shall be in the currency of the country of origin of the bidder or of the currency of an eligible member country widely used in international trade.

15.4 The Contracting Authority may request the bidders to explain the needs in national and foreign currencies and to justify that the amounts included in the unit and total prices and indicated in annex to the bids are reasonable; to this end, a detailed statement of their needs in foreign currencies shall be furnished by the bidder.

15.5 During the execution of the works, most of the foreign currency to be paid as part of Contract may be revised by mutual agreement between the Contracting Authority and the entrepreneur in a way as take account of any modification in the foreign currency needs within the context of the Contract.

#### **Article 16: Validity of bids**

16.1 Bids must remain valid during the period stated in the Special Regulations from the date of submission of the bids fixed by the Contracting Authority, in application of article 22 of the Special Regulations. A bid valid for a shorter period shall be rejected by the Contracting Authority or Contracting Authority as not being in compliance.

16.2 Under exceptional circumstances, the Contracting Authority may seek the approval of bidders to extend the validity time-limit. The request and the responses that will be given shall be in writing (or by fax). The validity of the bid bond provided for in article 17 of the General Regulations shall equally be extended for a corresponding duration. A bidder may refuse to extend the validity of his bid without losing his bid bond. A bidder who consents to an extension shall not be asked to modify his bid nor shall he be authorised to do so.

16.3 Where the Contract does not include a price revision clause and that the period of validity of bids is extended by more than sixty (60) days, the amounts payable to the bidder retained shall be updated by application of the related formula featuring in the request for extension that the Contracting Authority addressed to bidders.

The updating period shall run from the date of overrun of sixty (60) days to the date of notification of the Contract or the Administrative Order for start of execution of works by the retained bidder, as specified in the Special Administrative Conditions. The effect of updating shall not be taken into account for purposes of evaluation of bids.

#### **Article 17: Bid bond**

17.1 In application of article 13 of the General Regulations, the bidder shall furnish a bid bond of the amount specified in the Special Regulations and which bid bond shall be a full part of his bid.

17.2 The bid bond must conform to the model presented in the Tender File; other models may be authorised subject to the prior approval of the Contracting Authority. The bid bond will remain valid for thirty (30) days beyond the original date set for the validity of bids or any other validity time-limit requested by the Contracting Authority and accepted by the bidder, in accordance with the provisions of article 16 (2) of the General Regulations.

17.3 Any bid without an acceptable bid bond shall be rejected by the Tenders Board as not in conformity. The bid bond of associated enterprises must be established in the name of the group submitting the bid and mention each member of the associated grouping.

17.4 The bid bonds of bidders who are not retained shall be returned within fifteen (15) days after Publication of the award result.

17.5 The bid bond of the successful bidder shall be released as soon as the latter would have signed the Contract and furnished the required final bond.

17.6 The bid bond may be seized:

- (a) if the bidder withdraws his bid during the period of validity;
- (b) if the retained bidder:
  - i) fails in his obligation to register the Contract in application of article 38 of the General Regulations;

- ii) fails in his obligation to furnish the required final bond in application of article 38 of the General Regulations;
- iii) Refuses to receive notification of the Administrative Order to commence execution.

#### **Article 18: Varying proposals of bidders**

18.1 Where the works can be executed within variable deadlines, the Special Regulations shall specify these deadlines and shall indicate the method retained for the evaluation of the completion deadline proposed by the bidder within the specified deadlines. Bids that propose deadlines beyond those specified shall be considered as not being in conformity.

18.2 Except in the case mentioned in article 18(3) below, bidders wishing to offer technical variants must first assess the basic solution of the Contracting Authority as described in the Tender File and furnish in addition all the information which the Contracting Authority needs for a complete evaluation of the proposed variant, including the plans, calculations, technical specifications, sub-details of prices and proposed construction methods and all other useful information. If necessary, the Contracting Authority will examine only the technical variants of the bidder whose bid is in compliance with the basic solution has been evaluated as the lowest bid.

18.3 When according to the Special Regulations the bidders are authorised to directly submit the technical variants for certain parts of the works, these parts of the works must be described in the technical specifications. Such variants shall be evaluated on their own merit in accordance with the provisions of article 31(2) (g) of the General Regulations.

#### **Article 19: Preparatory meeting to the establishment of bids**

19.1 Except otherwise stipulated in the Special Regulations, a bidder may be invited to take part in a preparatory meeting which will hold at the date and place indicated in the Special Regulations.

19.2 The subject of the preparatory meeting shall be to furnish clarifications and answer any questions which may be raised at this stage.

19.3 As much as possible, the bidder is requested to submit any question in a way as to reach the Contracting Authority at least one week before the meeting. The Contracting Authority may not reply to questions received too late. In this case, the questions and answers shall be transmitted according to the methods set in article 19(4) below.

19.4 The minutes of the meeting, including the text of the questions asked and the replies given, including questions prepared after the meeting, shall be forwarded immediately to everyone who bought the Tender File. Any modification of documents of the Tender File listed in article 8 of the General Regulations which may prove to be necessary at the end of the preparatory meeting shall be done by the Contracting Authority by publishing an addendum in accordance with the provisions of article 10 of the General Regulations and not through the minutes of the preparatory meeting.

19.5 The fact that a bidder does not attend a preparatory meeting for the establishment of bids shall not be a reason for disqualification.

#### **Article 20: Form and signature of bid**

20.1 The bidder shall prepare an original of the constituent documents described in article 13 of the General Regulations in a volume clearly indicated "ORIGINAL". In addition, the bidder shall submit the number required in the General Regulations, bearing "COPY". In case of discrepancy, the original shall be considered as authentic.

20.2 The original and copies of the bid must be typed or written in indelible ink (photocopies shall be accepted in the case of copies) and shall be signed by the person(s) duly empowered to sign on behalf of the bidder, in accordance with article 6(1a) or 6(2c) of the General Regulations, as the case may be. All the pages of the bid containing alterations or changes must be initialled by the signatory (ies) of the bid.

20.3 The bid shall bear no modification, suppression or alteration unless such corrections are initialled by the signatory (ies) of the bid.

## D. SUBMISSION OF BIDS

### Article 21: Sealing and marking of bids

The Tender must be submitted by the Tenderer on the COLEPS Platform not later than    /    /2026 at **10:00am**. A backup copy of the Tender saved In a USB key or a CD/DVD must be sent in a sealed envelope with a clear and legible indication “backup copy” bearing the afore-mentioned label, within the time limit.

#### File Size and Format:

For online bidding, the maximum size of the documents that will be uploaded on the platform and constituting the bidder’s offer shall be;

- 5 Mb for Administrative offers;
- 15 Mb for the Technical offers;
- 5 Mb for the financial offers.

Supported formats shall include:

- PDF formats for texts documents;
- JPEG formats for images.

The Tenderer shall use a compression software to reduce the size of the file to be submitted.

### Article 22: Date and time-limit for submission of bids

22.1 The bids must be received by the Contracting Authority at the address specified in article 21(2) of the Special Regulations not later than the date and time stated in the Special Regulations.

22.2 The Contracting Authority may, at his discretion, postpone the deadline set for the submission of the bids by publishing an addendum in accordance with the provisions of article 10 of the General Regulations. In this case, all the rights and obligations of the Contracting Authority and bidders previously governed by the initial date will henceforth be governed by the new date.

### Article 23: Late bids

Any bid received by the Contracting Authority beyond the deadline for the submission of bids in accordance with article 22 of the General Regulations shall be declared late and consequently rejected.

### Article 24: Modification, substitution and withdrawal of bids

24.1 A bidder may modify or withdraw his bid after submitting it, on condition that the written notification of the modification or withdrawal is received by the Contracting Authority prior to the end of the time-limit prescribed for the submission of the bids. The said notification must be signed by an authorised representative in application of article 20(2) of the General Regulations. The modification or the corresponding replacement bid must be attached to the written notification. As the case may be, the bids must bear the inscription “**WITHDRAWAL**”, and “**REPLACEMENT BID**” or “**MODIFICATION**”.

24.2 Notification of modification, replacement or withdrawal of the bid by the bidder should be prepared, sealed, marked and forwarded in accordance with the provisions of article 21 of the General Regulations. Withdrawal may equally be notified by telex but should in this case be confirmed by a duly signed written notification whose date, post mark being authentic, shall not be posterior to the time-limit set for the submission of bids.

24.3 In application of article 24(1), bids being requested to be withdrawn by bidders shall be returned to them unopened.

24.4 No bid may be withdrawn during the interval between the submission of bids and the expiry of the validity of bids specified by the model tender. The withdrawal of a bid by a bidder during this interval may lead to the confiscation of the bid bond in accordance with the provisions of article 17(6) of the General Regulations.

## E. OPENING AND EVALUATION OF BIDS

### Article 25: Opening and petitions

- 25.1 The Internal Tenders Board shall open the bids in single or double phases and in the presence of the representatives of bidders who wish to attend at the date, time and address specified in the Special Regulations. Representatives of bidders shall sign a register attesting to their presence.
- 25.2 Firstly, bids marked “**withdrawal**” shall be opened and the contents announced to the hearing of everyone, while the envelope containing the corresponding bid shall be returned to the bidder unopened. Withdrawal shall be allowed only if the corresponding notification contains a valid empowerment of the signatory to request this withdrawal and if this notification is read to the hearing of everyone. Then the bids marked “**Replacement bid**” are opened and announced to the hearing of everyone and the new corresponding bid substituted for the preceding one which will be sent to the bidder concerned unopened. The replacement of the bid shall only be allowed if the corresponding notification contains a valid empowerment of the signatory requesting the replacement and read to the hearing of everyone. Lastly, the bids marked “**modification**” shall be opened and their contents read to the hearing of everyone with the corresponding bid. The modification of the bid shall only be allowed if the corresponding notification contains a valid empowerment of the signatory requesting the modification and read to the hearing of everyone. Only bids which were opened and announced to the hearing of everyone during the opening of bids shall then be evaluated.
- 25.3 All bids shall be opened successively and the name of the bidder announced aloud as well as the possible modification mentioned, the price offered, including any rebates [*in case of opening of financial bids*] and any variant, where necessary, the existence of a guarantee of the bid if it is required and any other details which the Contracting Authority deems useful to be mentioned. Only rebates and variants of bids announced to the hearing of everyone during the opening of bids shall be submitted for evaluation.
- 25.4 Bids (and modifications received in accordance with the provisions of article 24 of the General Regulations) which were not opened and read to the hearing of everyone during the bid- opening session for whatever reason, shall not be submitted for evaluation.
- 25.5 Bid- opening minutes are recorded on the spot mentioning the admissibility of bids, their administrative regularity, prices, rebates and time-limits as well as the composition of the Evaluation sub-committee. A copy of the said minutes to which is attached the attendance sheet is handed over to all the participants at the end of the session.
- 25.6 At the end of each bid- opening session, the chairperson of the Tenders Board immediately hands over to the focal point designated by the body in charge of regulation of Public Contracts an initialled copy of the bids presented by bidders.
- 25.7 In case of petition as provided for by the Public Contracts Code, it should be addressed to the Minister Delegate in charge of Public Contracts with a copies to the body in charge of the regulation of Public Contracts, the head of structure to which is attached the Tenders Board concerned.
- It must reach within a maximum deadline of three (3) working days after the opening of bids in the form of a letter to which is obligatorily attached a sheet of the petition form duly signed by the petitioner and possibly by the chairperson of the Tenders Board.
- The Independent Observer attaches to his report the sheet that was handed to him, including any related commentaries or observations.

#### **Article 26: Confidential nature of the procedure**

- 26.1 No information relating to the examination, clarification, evaluation and comparison of bids and verification of the qualification of the bidders and the recommendation for the award shall be given to bidders or to any person not concerned with the said procedure as long as the preferred bidder has not been made Public, subject to the disqualification of the bid of the bidder and suspension of the authors from all activities in the domain of Public Contracts.

26.2 Any attempt by a bidder to influence the Tenders Board or the Evaluation sub-committee of bids or the Contracting Authority in its award decision may lead to the rejection of his bid.

26.3 Notwithstanding the provisions of paragraph 26.2 above, between the opening of bids and the award of the Contract, if a bidder wishes to enter into contact with the Contracting Authority for reasons having to do with his bid may do so in writing.

#### **Article 27: Clarifications on the bids and contact with the Contracting Authority**

27.1 To ease the examination, evaluation and comparison of bids, the Tenders Board may, if it so desires, request any bidder to give clarifications on his bid. This request for clarification and the response thereto are formulated in writing but no change on the amount or content of the bid is sought, offered or authorised, except it is necessary to confirm the correction of calculation errors discovered by the Evaluation Sub-committee during the evaluation in accordance with the provisions of article 30 of the General Regulations.

27.2 Subject to the provisions of paragraph 1 above, bidders shall not contact members of the Tenders Board and the Evaluation Sub-committee for questions related to their bids, between the opening of bids and the award of the Contract.

#### **Article 28: Determination of compliance of bids**

28.1 The Evaluation sub-committee shall carry out a detailed examination of bids to determine if they are complete, if the required guarantees are furnished, if the documents were correctly signed and if generally the bids are in proper order.

28.2 The Evaluation sub-committee shall determine if the bid is essentially in compliance with the conditions fixed in the Tender File based on the content without recourse to external elements of proof.

28.3 A bid that complies with the Tender File shall essentially be a bid that respects all the terms, conditions and specifications of the Tender File, without substantial divergence or reservation. A substantial divergence or reservation is that:

- i) which substantially limits the scope, quality or realisation of the works;
- ii) which substantially limits, contrary to the Tender File, the rights of the Contracting Authority or his obligations in relation to the Contract;
- iii) Whose correction would unjustly affect the competitiveness of the other bidders who presented bids that essentially complied with the Tender File.

28.4 If a bid is essentially not in compliance, it shall be rejected by the competent Tenders Board and shall not subsequently be rendered in compliance.

28.5 The Contracting Authority reserves the right to accept or reject any modification, divergence or reservation. Modifications, divergences, variants and other factors which are beyond the requirements of the Tender File shall not be considered during the evaluation of bids.

#### **Article 29: Qualification of the bidder**

The Evaluation sub-committee shall ensure that the successful bidder retained for having submitted a bid substantially in compliance with the provisions of the Tender File, fulfils the qualification criteria stipulated in article 6 of the Special Regulations. It is essential to avoid any arbitrariness in determining qualification.

#### **Article 30: Correction of errors**

30.1 The Evaluation sub-committee shall verify bids considered essentially in compliance with the Tender File to correct the possible calculation errors. The Evaluation sub-committee shall correct the errors in the following manner:

- (a) where there is an incoherence between the unit price and the total obtained by multiplying the unit price by the quantity, the unit price being authentic, the total price shall be corrected, unless the

Evaluation sub-committee judges that it is a gross error of decimal point in the unit price in which case the total price as presented shall be authentic and the unit price corrected.

- (b) if the total obtained by addition or subtraction of the totals is not exact, the sub totals shall be considered authentic and the total corrected.
  - (c) where there is a difference between the price indicated in letters and in figures, the amount in letters shall be considered authentic, unless the amount is linked to an arithmetical error confirmed by the sub-detail of the said price, in which case the amount in figures shall prevail subject to paragraphs (a) and (b) above.
- 30.2 The amount featuring in the bid shall be corrected by the Evaluation sub-committee, in accordance with the error correction procedure above and with confirmation by the bidder, the said amount shall be deemed to commit him.
- 30.3 If the bidder who presented the bid evaluated as the lowest refuses the correction thus carried out, his bid shall be rejected and the bid bond may be seized.

#### **Article 31: Conversion into a single currency**

- 31.1 To facilitate the evaluation and comparison of bids, the Evaluation sub-committee shall convert the prices of bids expressed in various currencies into those in which the bid is payable in CFA francs.
- 31.2 The conversion shall be done using the selling rate fixed by the Bank of Central African States (BEAC) under the conditions defined by the Special Regulations.

#### **Article 32: Evaluation and comparison of financial bids**

- 32.1 Only bids considered as being in compliance, as per the provisions of article 28 of the General Regulations, shall be evaluated and compared by the Evaluation sub-committee.
- 32.2 By evaluating the bids, the Evaluation Sub-committee shall determine for each bid the evaluated amount of the bid by rectifying the amount as follows:
- a) By correcting any possible error in accordance with the provisions of article 30.2 of the General Regulations;
  - b) By excluding projected sums and where necessary provisions for unforeseen occurrences featuring in the bill of quantities and estimates but by adding the amount of works done under State supervision where they are costed in a competitive manner as specified in the Special Regulations.
  - c) By converting into a single currency the amount resulting from the rectifications (a) and (b) above, in accordance with the provisions of article 31(2) of the General Regulations;
  - d) By appropriately adjusting any other modification, divergence or quantifiable reservation on technical or financial basis.
  - e) By taking into consideration the various execution time-limits proposed by the bidders, if they are authorised by the Special Regulations;
  - f) If need be, in accordance with the provisions of article 13(2) of the General Regulations and the Special Regulations by applying the rebates offered by the bidder for the award of more than one lot, if this Invitation to Tender is launched simultaneously for several lots.
  - g) If need be, in accordance with the provisions of article 18(3) of the Special Regulations and the Technical Specifications, the proposed technical variants, if they are permitted, shall be evaluated on their own merit and independently of the fact that the bidder offered or not a price for the technical solution specified by the Contracting Authority in the Special Regulations.
- 32.3 The estimated effect of price revision formulae featuring in the GAC and SAC applied during the period of execution of the Contract shall not be considered during the evaluation of bids.
- 32.4 If the bid judged the lowest bid is considered abnormally low or strongly unbalanced in relation to the estimates of the Project Owner for the works to be executed in this Contract, the Tenders Board may, from the sub-details of prices furnished by the bidder for any element or all the elements of the bill of quantities and estimates, verify if these prices are compatible with the construction methods and proposed calendar. In

the case where the justifications presented by the bidder are not satisfactory, the Contracting Authority may reject the bid after the technical opinion of the Public Contracts Regulatory Agency.

**Article 33: Preference granted national bidders**

National Contractors shall benefit from a margin of national preference during the evaluation of bids as provided for in the Public Contracts Code.

**Article 34: Award**

34.1 The Contracting Authority shall award the Contract to the bidder whose bid was judged essentially in compliance with the Tender File and who has the required technical and financial capacities to execute the Contract satisfactorily and whose bid was evaluated as the lowest by including, where necessary, proposed rebates

34.2 If, according to article 13(2) of the General Regulations, the Invitation to Tender comprises several lots, the lowest bid shall be determined by evaluating this Contract with other lots to be awarded concurrently, by taking into account the rebates offered by the bidders in the case of more than one lot.

34.3 Any award of Contract shall be made to the bidder fulfilling the technical and financial capacities required resulting from the evaluation criteria and presenting the bid evaluated as the lowest.

**Article 35: The right by the Contracting Authority to declare an Invitation to Tender unsuccessful or cancel a procedure**

The Contracting Authority reserves the right to cancel a procedure of Invitation to Tender after the authorisation of the Minister Delegate at the Presidency in charge of Public Contracts where the bids have been opened or to declare an Invitation to Tender unsuccessful after the advice of the competent Tenders Board, without any claims being entertained.

**Article 36: Notification of award of the Contract**

Before the expiry of the validity of the bids set in the Special Regulations, the Contracting Authority shall notify the preferred bidder by telecopy confirmed by registered mail or by any other means that his bid was retained. This letter will indicate the amount the Project Owner will pay the Contractor to execute the works and the execution time-limit.

**Article 37: Publication of results of award and petitions**

37.1 The Contracting Authority shall communicate to any bidder or administration concerned, upon request addressed to it within a maximum deadline of five (5) days after Publication of the award results, the Independent Observer's report as well as the minutes of the award session of the related Contract to which shall be attached the evaluation report of the bids.

37.2 The Contracting Authority is bound to communicate the reasons for the rejection of bids of the bidders concerned who so request.

37.3 After Publication of the award results, bids that are not withdrawn within fifteen (15) days shall be destroyed, without any claims for compensation being entertained. Only the copy destined for the body in charge of regulation shall be kept.

37.4 In case of petition, it should be addressed to the Public Contracts Authority, with copies to the body in charge of the regulation of Public Contracts, the Contracting Authority and the chairperson of the Tenders Board concerned.

It must take place within a maximum deadline of five (5) working days after the Publication of the results.

**Article 38: Signing of the Contract**

38.1 After Publication of the results, the draft Contract subscribed by the successful bidder is submitted to the Tenders Board for examination and where applicable, to the Minister in charge of Public Contracts for prior endorsement.

38.2 The Contracting Authority has a deadline of seven (7) days to sign the Contract from the date of reception of the draft Contract examined by the competent Tenders Board and subscribed by the successful bidder and where applicable, the endorsement of the Minister in charge of Public Contracts.

38.3 The Contract must be notified to the successful bidder within five (5) days of its date of signature.

**Article 39: Final Bond**

39.1 Within twenty (20) days of the notification by the Contracting Authority, the Contractor shall furnish the Project Owner with a final bond, to guarantee the complete execution of the works.

39.2 The bond whose rate varies between 2 and 5 percent of the amount of the Contract inclusive of all taxes, may be replaced by a guarantee from a banking establishment approved according to the instruments in force with the Project Owner as beneficiary or by a joint or several guarantee.

39.3 Small and medium-sized enterprises (SME) constituted of national capital and managed by nationals may, in lieu of the guarantee, provide a statutory lien or a bond issued by a banking establishment or first rate financial institution approved in accordance with the instruments in force.

39.4 Failure to produce the final bond within the prescribed time limit shall likely cause the termination of the Contract under the terms laid down in the General Administrative Conditions.

**Document N°. 3**  
**SPECIAL REGULATIONS OF THE**  
**INVITATION TO TENDER**

## SPECIAL REGULATIONS OF THE INVITATION TO TENDER

References of the General regulations	Description
1	<p><b>Definition of works:</b>  <b>FOR THE PHASE II CONSTRUCTION AND COMPLETION OF A THEATRE BLOCK AT NKWEN DISTRICT HOSPITAL (RELAUNCH).</b>                      Name and address of the Contracting Authority: The President of the North West Regional Assembly                      Reference of Invitation to Tender: N° ___/ONIT/NWRA/NWRAITB/2026 of ___/___/2026</p>
2	Execution deadline: <b>Four (04) Months per lot</b>
3	<p><b>Source of financing</b>                      Works which form the subject of this Invitation to Tender shall be financed by the 2026 Public Investment Budget assigned to the North West Regional Assembly</p>
4	List of pre-qualified candidate. Not applicable
5	Origin of building materials, equipment, and supplies: The materials will generally be from natural sources in Cameroon or imported.

### 6.1 Evaluation criteria

The bids shall be evaluated according to the main criteria as follows:

#### C. Eliminary criteria

1. Absence or non-conformity of an element in the administrative file non regularized within 48 hours after opening of bids
2. Execution deadline higher than prescribed in the Tender File;
3. False declaration or falsified documents;
4. Absence or insufficient bid bond;
5. A bid with the external envelope carrying a sign leading to the identification of the bidder;
6. Incomplete financial file;
7. Non respect of **75%** of essential criteria;
8. Suspended by MINMAP for 2026.
9. Average annual turnover of at least the tendering amount (Average annual turnover calculated as total certified payments received for contracts in progress or completed, within the last five (5) years (from 2021). This should be justified by copies of past contracts (completed or ongoing). Final reception minutes for all completed contracts before 2026 and provisional reception minutes for contracts completed in 2025 should be presented.
10. Failure to provide a backup copy of offers saved in a USB key or a CD/DVD on time;
11. Failure to comply with the format of file type and size for online submission;
12. Failure to present a CDEC receipt or proof of deposit of the amount of the bid bond requested into the Deposit and Guarantee Fund;
13. Failure to present a certificate of categorization or receipt of deposit of file for categorisation of the enterprise in the "**Building and General Equipment**" sub-sector of activities.

#### D. Essential criteria

- 1- General presentation of the Tender Files;
- 2- Financial capacity;
- 3- References of the company in similar achievements visa by the competent administrative authority;
- 4- Quality of the personnel;
- 5- Technical organization of the works;

- 6- Safety measures on the site;
- 7- Logistics;
- 8- Attestation of site visit duly signed on honour by the bidder and report of site visit with pictures;
- 9- Special Technical Clauses initialed in all the pages, signed and dated at the last page;
- 10- Special Administrative Clauses completed and initialed in all the pages, signed and dated at the last page.

The criteria relating to the qualification of candidates could be indicative on the following:  
The essential criteria are subjected to minima whose detail is given in the Special Tender Regulation (RPAO).

This evaluation will be done in a purely positive way (yes) or negative (no) with an acceptable minimum from at least 75% of the essential criteria taken in account.

The Contract will be awarded to the bidder who would have proposed the offer with the lowest amount, in conformity with the regulations of the Tender Documents and having satisfied **100%** of the eliminatory criteria and at least **75%** of the essential criteria. A bidder can bid for more than one lot but can be awarded only one lot.

**ARTICLE 6: Language of the bids:**

The offer like any correspondence and all documents concerning the tender, exchanged between the tenderer and the Project Owner will be written in French or English. The complementary documents and the printed papers form provided by the Bidder can be written in another language on condition of being accompanied by a precise translation in French or English; in which case and for purposes of interpretation of the offer, the translation will be taken.

**7. PRESENTATION OF THE TENDER**

**ENVELOPE A: ADMINISTRATIVE DOCUMENTS:** It shall contain the administrative documents of the enterprise. These documents shall be original or copies certified by competent authorities not more than three months.

**ADMINISTRATIVE DOCUMENTS.**

DOCUMENT N°	DESCRIPTION
A.1	Declaration of intention to tender stamped with the tariff in force (written by the bidder) with a fiscal stamp.
A.2	Certified Copy of the Business Registration, not more than three months old.
A.3	Certificate of non-bankruptcy established by the Court of 1st instance or the Chamber Commerce, Industry and Trade of the place of residence of the bidder, not more than three (03) months.
A.4	Attestation of bank account of the bidder, issued by a first rate-bank approved by the Ministry in charge of Finance. (See list of approved banks on page 103 of this tender file)
A.5	Purchase receipt of Tender File issued by North West Regional Assembly Treasury
A.6	A bid bond issued by a first rate-financial institution approved by the Ministry in charge of Finance in conformity with COBAC conditions and a CDEC receipt or proof of deposit of the amount of the bid bond requested into the Deposit and Guarantee Fund.
A.7	An attestation of non-exclusion from Public Contracts issued by the Public Contracts Regulatory Board (ARMP)
A.8	An Attestation of the National Social Insurance Fund stating that the bidder has met all his obligations vis a vis the Fund; the attestation valid within the given time.
A.9	Tax compliance certificate or Clearance Certificate signed by the chief of Centre of Taxes that the bidder has met all the statutory declarations in issues of taxes in the current financial year; this certificate should be less than three months old.
A.10	Copy of a valid taxpayer's card, delivered by the chief of center of Taxes.
A.11	I certified copy by MINMAP of the certificate of categorization or receipt of deposit of file

	for categorisation of the enterprise in the “Building and General Equipment” sub-sector of activities
A.12	Plan and attestation of location of the Company signed by the bidder on honour
A.13	Power of attorney if necessary
A.14	Group agreement where applicable
A.15	Special Technical Clauses initialed on all the pages and signed, dated and stamped on the last page.
A.16	Special Administrative Clauses completed and initialed on all the pages, signed, dated and stamped on the last page.

**ENVELOPE B: TECHNICAL DOCUMENT:** It shall contain the following:

<b>A. General presentation of bids</b>	
- Presence of all documents .....	yes/no
- Properly bound.....	yes/no
- Table of content .....	yes/no
- Separators in colour apart from white.....	yes/no
- Order prescribed respected.....	yes/no
- Clearness of the documents.....	yes/no
<b>TOTAL 1</b>	<b>/6</b>
<b>B. The company references</b>	
References of the company in similar works for the past ten (10) years:	
- 01 certified copy of similar contract visa and legalized by a competent administrative authority equal or above 98 million FCFA ATI (1 <sup>st</sup> and last pages) and PV of final reception for works realized before 2025 and provisional reception for works realized in 2025.	yes/no
- 01 certified copy of similar contract visa and legalized by a competent administrative authority equal to or more than 50 million CFA ATI (1 <sup>st</sup> and last pages) and PV of final reception for works realized before 2025 and provisional reception for works realized in 2025.	yes/no
- 01 certified copy of similar contract visa and legalized by a competent administrative authority below 50 million and above 25 million (1 <sup>st</sup> and last pages) and PV of final reception for works realized before 2025 and provisional reception for works realized in 2025.	yes/no
<b>TOTAL 2</b>	<b>/3</b>
<b>C. Equipment</b>	
- Proof of ownership or hire of a dump truck .....	yes/no
- Proof of ownership or hire of a 4x4 pick-up vehicle in good operating condition .....	yes/no
- Proof of ownership of a vibrator in good operating condition ...	yes/no
- Proof of ownership or hire of a concrete mixer of at least 0.5m <sup>3</sup> volume .....	Yes/no
- Proof of ownership of masonry tool kids .....	yes/no
- Proof of ownership of electrical tool kid .....	yes/no
- Prof of ownership of carpentry tool kids .....	yes/no
- Proof of ownership or hire of plumbing tool kids .....	yes/no

TOTAL 3	/8
<b>D. Qualification of site personnel</b>	
- Organizational Chart of the enterprise.....	yes/no
- Organizational Chart of site with comments .....	yes/no
<b>Works Director: Civil Engineer with at least 05 years of working experience</b>	
- Diploma of work Director certified.....	yes/no
- Attestation of presentation of original diploma works director .....	yes/no
- CV signed and dated by works Director.....	yes/no
- Professional experience of works Director above five years.....	yes/no
- Attestation of availability dully signed by the works director .....	yes/no
<b>Site foreman: Senior technician in Civil Engineering with at least 05 years of working experience</b>	
- Certified copy of certificate of site foreman.....	yes/no
- Attestation of presentation of original diploma of site foreman .....	yes/no
- CV signed and dated by site foreman.....	yes/no
- Professional experience of site foreman above five years .....	yes/no
- Attestation of availability of site foreman .....	yes/no
<b>Chief builder: BAC in Civil Engineering with at least three years of working experience</b>	
- Certified copy of diploma of chief builder.....	yes/no
- Attestation of presentation of original diploma of Chief Builder ...	yes/no
- CV signed and dated by Chief Builder .....	yes/no
- Attestation of availability of Chief Builder .....	Yes/no
<b>Chief carpenter: BAC in wood work with at least three years of working experience</b>	
- Certified copy of diploma of chief carpenter.....	yes/no
- Attestation of presentation of original diploma of Chief Carpenter ....	yes/no
- CV signed and dated by Chief Carpenter .....	yes/no
- Attestation of availability of Chief Carpenter .....	Yes/no
<b>Chief Electrician: BAC in Electricity with at least three years of working experience</b>	
- Certified copy of diploma of chief electrician .....	yes/no
- Attestation of presentation of original diploma of chief electrician .....	yes/no
- CV signed and dated by chief electrician .....	yes/no
- Attestation of availability of chief electrician .....	Yes/no
<b>Chief Plumber: CAP in plumbing with at least three years of working experience</b>	
- Certified copy of diploma of chief plumber .....	yes/no
- Attestation of presentation of original diploma of chief plumber..	yes/no
- CV signed and dated by chief plumber .....	yes/no
- Attestation of availability of chief plumber	Yes/no
<b>Chief painter: CAP/trade certificate in painting at least three years</b>	

- Certified copy of diploma of chief painter .....	yes/no
- Attestation of presentation of original diploma of chief painter ...	yes/no
- CV signed and dated by chief painter .....	yes/no
- Attestation of availability of chief painter .....	Yes/no
<b>TOTAL 4</b>	<b>/31</b>
<b>E. The methodology of intervention and execution of work</b>	
- Attestation of site visit signed by the bidder on honour.	yes/no
- Site Visit report signed and dated by bidder or dully authorised representative with pictures .....	yes/no
- Detailed technical note on the organization and execution of works...	yes/no
- Coherence synchronized planning of execution of works.....	yes/no
- Coherence of Individual Protection Plan (IPP) within the building site...	yes/no
- Coherence of the General Security and Safety Plan (GSSP) within the building site...	yes/no
- Description of the socio - environment measures for site protection.....	yes/no
- Coherence in the methodology of execution of works .....	yes/no
- Coherence in the organization of the site.....	yes/no
-Plan of supply of constructional materials and storage conditions .....	yes/no
- CCTP dully initialled on each page, signed and dated on the last page	yes/no
<b>TOTAL 4</b>	<b>/11</b>
<b>F- Pre-financing</b>	
Attestation of credibility shall be at least 80% of the bid price issued by a first rate banking institution.....	yes/no
<b>TOTAL</b>	<b>/1</b>
<b>TOTAL = TOTAL1 + TOTAL2+ TOTAL3+ TOTAL4+ TOTAL5 + TOTAL6</b>	<b>/60</b>

### ENVELOPE C- FINANCIAL FILE

The third internal envelope shall be labled and shall contain the following documents:

No.	DESIGNATION.
C1	A submission letter, signed, dated and stamped.(see ANNEX 3)
C2	Completed and signed frame work of unit prices.
C3	Signed Bills of quantities and cost estimates indicating the total amount without taxes (HT) and with taxes (TTC)
C4	Sub details of unit prices

- The bidders will use for this purpose the documents and models envisaged in the Tender Documents, subject to the provisions of Article 12.2 of the General Regulation of the Invitation to Tender (GRIT) concerning the other possible forms of bid bond.
- The various parts of the same file must be separated with colour guides from as well in the original as in the copies, so as to facilitate its examination

The Tender must be submitted by the Tenderer on the COLEPS Platform not later than  / /2026 at 10:00am. A backup copy of the Tender saved In a USB key or a CD/DVD must be sent in a sealed envelope with a clear and legible indication "backup copy" within the time limit bearing the label:

OPEN NATIONAL INVITATION TO TENDER FILE  
 N° \_\_\_\_\_/ONIT/NWRA/ITB/2026 OF \_\_\_\_/\_\_\_\_/2026 FOR THE PHASE II CONSTRUCTION AND  
 COMPLETION OF A THEATRE BLOCK AT NKWEN DISTRICT HOSPITAL (RELAUNCH)  
**"To be opened only during the bid-opening session"**

**File Size and Format:**

For online bidding, the maximum size of the documents that will be uploaded on the platform and constituting the bidder's offer shall be;

- 5 Mb for Administrative offers;
- 15 Mb for the Technical offers;
- 5 Mb for the financial offers.

Supported formats shall include:

- PDF formats for texts documents;
- JPEG formats for images.

The Tenderer shall use a compression software to reduce the size of the file to be submitted.

## CONTRACT PRICE

**ARTICLE 8: Currency of payment**

This National Invitation to tender is awarded on total and Contractual price, inclusive of all taxes, firm and non-revisable for the works defined in the present Invitation to Tender.

The corresponding amount will be calculated inclusive of all taxes and the prices will be obligatorily expressed in francs CFA.

The unit schedule price expressed out in figures and letters and in seven (07) copies will be joined to the offer. In the event of error between the prices in figures and letters, the latter will precede and be used as a basis of calculation of the amount of the offer.

The establishment of the prices will be done on the basis of economic condition into force in Republic of Cameroon at the handover date of the offers.

**ARTICLE 9: Transport and delivery**

The materials for work must be protected during transportation through packaging whether by air, railway or road according as the case may be. The conditions of storage must be of tropical type.

**ARTICLE 10: Guarantee and retention guarantee**

**10.1 Provisional guarantee**

The amount of the provisional guarantee or guarantee of tender is fixed as of the table below:

LOT No.	PROJECT	AMOUNT	AMOUNT OF BID BOND	TENDER FILE FEE
01	phase II construction and completion of a theatre block at Nkwén District Hospital	98,000,000	1,960,000	98,600

The time of validity of this guarantee is one hundred and twenty (120) days as from the date of depositing of the offers. It must also have a CDEC receipt or proof of deposit of the amount of the bid bond requested into the Deposit and Guarantee Fund.

**10.2 Final Bond**

The final Bond is fixed at two percent (2%) maximum of the initial amount of the services envisaged in the contract.

It could be replaced by a personal guarantee from a banking institution approved by the Ministry of Finances, following COBAC conditions.

It will have to be made up in twenty (20) days following the notification of the signature of the Contract from a bank approved by the Minister in charge of Finances.

It must also have a CDEC receipt or proof of deposit of the amount of the final bond requested into the Deposit and Guarantee Fund.

### **10.3 Guarantee Retention**

The Guarantee Retention shall be set at ten percent (10%) of the contract amount inclusive of all taxes. The Guarantee Retention can be deducted or cautioned. If cautioned, the guarantee Retention is issued by a first rate banking institution or insurance company and must also have a CDEC receipt or proof of deposit of the amount of the guarantee Retention requested into the Deposit and Guarantee Fund.

### **ARTICLE 11: Period of validity of the offers**

The bidder will remain committed to his offer for Ninety (90) days as from the handover date of the offers.

If at the end of this period, the Contract is not notified to him, the bidder will be able, either to cancel his offer, or to ask for a new negotiation of the unit prices.

### **ARTICLE 12: Number of copies to be submitted**

For Online submission, see article 7 page 34.

### **ARTICLE 13: Date and latest time of submission of bids**

The backup copy of offers saved in a USB key or a CD/DVD will have to arrive under closed fold and seal latest / /2026 at 10:00am, by mail registered with acknowledgement of delivery or by deposit against receipt to the following address: Office of the Director of General Affairs at the North West Regional Assembly, North West (Tel N° 2 33 36 00 92) or submitted online using the address: [www.marchespublics.cm](http://www.marchespublics.cm). Beyond this time no offer will be received nor accepted.

### **ARTICLE 14: Opening of the bids**

The opening of the bids will be carried out in the conference room of **The President of the North West Regional Assembly Internal Tenders' Board** on / /2026 as from **11: 00am**, by the Regional Assembly Internal Tenders' Board sitting in the presence of the bidders or their mandated representatives having a good knowledge of the file.

## **AWARD OF THE CONTRACT**

### **ARTICLE 15: Award of the Contract**

The Tenders Board will propose to the Contracting Authority to award the Contract to the bidder who will have presented the offer with the lowest amount, essentially conforming to the regulations of the Tender File, having satisfied **100% of all the eliminatory criteria and at least 75% of the essential criteria** taken into account. **(A Bidder can bid for more than one Lot but can be awarded only one Lot)**

The decision carrying attribution of the Contract will be published by way of press release or any other means of Publication of use in the Administration.

If the Contract passed on the basis of technical alternative suggested by the bidder, the Contracting Authority reserves the right to introduce all the provisions there allowing him to guarantee itself against the real overrun costs of the alternative compared to his estimate of origin. In the absence of these last precise details, any additional charge due to an alternative will be inadmissible.

To this end, it is specified that a bidder cannot claim to be compensated, if it is not taken action on his offer.

The Contracting Authority reserves the right not to take action on an Invitation to Tender, if it did not obtain a proposal which appears acceptable to him.

## ARTICLE 16: SITE INSTALLATION

Before the commencement of works, the Contractor must be installed on the site by the following:

- ❖ The President of the North West Regional Assembly or his representative (Chairman)
- ❖ The Contract Manager
- ❖ The Contract Engineer (Secretary)
- ❖ The Regional Delegate MINMAP North-West or his representative;
- ❖ The Regional Delegate MINEPAT North-West or his representative;
- ❖ Contractor
- ❖ The Beneficiary (Observer)
- ❖ The Commissioner incharge of Health NWRA (Observer)

**Document N°. 4**  
**SPECIAL ADMINISTRATIVE CONDITIONS**  
**(SAC)**

## Table of contents

### Chapter I: General

- Article 1 - Subject of the Contract
- Article 2 - Award procedure
- Article 3 - Definitions and duties (article 2 of GAC supplemented)
- Article 4 - Language, applicable law and regulations
- Article 5 - Constituent documents of the Contract (article 4 of GAC)
- Article 6 - General applicable instruments
- Article 7 - Communication (GAC articles 6 and 10 supplemented)
- Article 8 - Administrative Orders (article 8 of GAC supplemented)
- Article 9 - Contracts with conditional phases (article 15 of GAC)
- Article 10 - Contractor's personnel (article 15 of GAC supplemented)

### Chapter II: Financial conditions

- Article 11 - Guarantees and bonds (articles 29 and 41 of GAC supplemented)
- Article 12 - Amount of Contract (articles 18 and 19 supplemented)
- Article 13 - Place and method of payment
- Article 14 - Price variation (article 20 of GAC)
- Article 15 - Price revision formulas
- Article 16 - Price updating formulas (article 21 of GAC)
- Article 17 - Work under State supervision (article 22 of GAC supplemented)
- Article 18 - Evaluation of works (article 23 supplemented)
- Article 19 - Evaluation of supplies (article 24 of GAC) supplemented)
- Article 20 - Advances (article 28 of GAC)
- Article 21 - Payments for the works (articles 26, 27 and 30 of GAC supplemented)
- Article 22 - Interests on overdue payments (article 31 of GAC supplemented)
- Article 23 - Penalties for delay (article 32 of GAC supplemented)
- Article 24 - Payment in case of a group of enterprises (article 33 of GAC)
- Article 25 - Final detailed account (article 35 of GAC)
- Article 26 - General detailed account (article 35 of GAC)
- Article 27 - Tax and customs schedule (article 36 of GAC)
- Article 28 - Stamp duty and registration (article 37 of GAC)

### Chapter III: Execution of the works

- Article 29 - Nature of works
- Article 30 - Obligations of the Project Owner (GAC supplemented)
- Article 31 - Execution deadline of Contract (article 38 of GAC)
- Article 32 - Roles and responsibilities of the Contractor (article 40 of GAC)
- Article 33 - Making available documents and site (article 42 of GAC)
- Article 34 - Insurance of structures and civil responsibility (article 45 of GAC)
- Article 35 - Documents to be furnished by the Contractor (article 49 supplemented)
- Article 36 - Organisation and security of sites (article 50 of GAC)
- Article 37 - Implantation of structures (article 52 of GAC)
- Article 38 - Sub-Contracting (article 54 of GAC)
- Article 39 - Site laboratory and trials (article 55 of GAC)
- Article 40 - Site logbook (article 56 of GAC supplemented)
- Article 41 - Use of explosives (article 60 of GAC)

### Chapter IV: Acceptance

- Article 42 - Provisional acceptance (article 67 of GAC)
- Article 43 - Documents to be furnished after execution (article 68 of GAC)
- Article 44 - Guarantee time-limit (article 70 of GAC)
- Article 45 - Final acceptance (article 72 of GAC)

### Chapter V: Miscellaneous provisions

- Article 46 - Termination of the Contract (article 74 of GAC)
- Article 47 - Force majeure (article 75 of GAC)
- Article 48 - Differences and disputes (article 79 of GAC)
- Article 49 - Drafting and dissemination of this Contract
- Article 50 and last: Entry into force of the Contract

## CHAPTER I: GENERAL

### Article 1: Subject of Contract

The subject of this Contract shall be **FOR THE PHASE II CONSTRUCTION AND COMPLETION OF A THEATRE BLOCK AT NKWEN DISTRICT HOSPITAL (RELAUNCH).**

### Article 2: Contract award procedure

This Contract is awarded by Open National Invitation to Tender No \_\_\_\_\_/ONIT/NWRA/ITB/2026 of \_\_\_/\_\_\_/2026.

### Article 3: Definitions and duties (article 2 of GAC supplemented)

#### 3.1 *General definitions (cf. Code)*

- ✓ The Contracting Authority shall be **The President of the North West Regional Assembly**; in this respect he preserves the original documents relating to the contract and transmits copies to the Public Contract Regulatory Agency.
- ✓ The Contract Manager shall be **The Director of General Affairs at the North West Regional Assembly**. In this capacity, he shall respect the administrative, technical and financial clauses of this contract.
- ✓ The Contract Engineer shall be **The Regional Delegate of Public Works for the North-West**. He shall validate the different crucial phases of work done, from the installation of the Contractor to the Provisional Technical Reception.
- ✓ **The Regional Delegation of MINMAP North-West** shall carry out unannounced control for the execution of this project
- ✓ **The Divisional/Sub-Divisional Peace and Development Committees (P.D.C)** shall carryout Social Control and report to the President of the Regional Assembly.
- ✓ **The Contractor shall be [to be specified].**

#### 3.2 *Security*

This Contract may be used as security subject to any form of transfer of the debt.

In this case:

- The authority in charge of ordering payment shall be **The President of the North West Regional Assembly**.
- The body or official in charge of payment shall be **The Paymaster General North West Region**.
- The official competent to furnish information within the context of execution of this Contract shall be **The Director of General Affairs at the North West Regional Assembly**.
- The authority in charge of clearance shall be **The Specialised Finance Controller of the North West Regional Assembly**.

#### 3.3 Duties of the Control Mission, Project Manager (Not applicable)

##### 3.3.1 Control Missions [to be specified].

### Article 4: Language, law and regulation applicable

1.1 The language to be used shall be *[English and/or French]*.

1.2 The Contractor shall be bound to observe the law, regulations and ordinances in force in Cameroon both within his own organization and in the execution of the Contract.

If the laws and regulations in force at the date of signature of this Contract are amended after the signature of the Contract, the possible direct resulting costs shall be taken into account without gain or loss for either party.

### Article 5: Constituent documents of the Contract (Article 4 of GAC)

The constituent Contractual documents of this Contract are in order of priority:

- 1) The tender or commitment letter;
- 2) The bidder's tender and its annexes in all provisions not contrary to the Special Administrative Conditions (GAC) and the Special Technical Conditions (STC) hereunder;

- 3) The Special Administrative Conditions (SAC);
- 4) The Special Technical Conditions (STC);
- 5) The particular elements necessary for the determination of the Contract price, such as, in order of priority: the unit price schedule, the statement of all-in prices, detailed estimates, the breakdown of all-in prices and the sub-details of unit prices;
- 6) Plans, calculation notes, trial documents, geotechnical documents;
- 7) The General Administrative Conditions applicable on Public works Contracts that went into effect by Order No. 033/CAB/PM of 13 February 2007;
- 8) The General Technical Condition(s) applicable on the services forming the subject of the Contract.

**Article 6: General instruments in force**

This Contract shall be governed by the following general instruments:

1. Law No 2018/011 of 11 July, 2018 on the Code of Transparency and Good Governance in the management of Public Finances in Cameroon;
2. Law No 2018/012 of July 11, 2018 on the financial regime of the state and other public entities;
3. Law No 2019/024 of December 24, 2019 on the General code of Regional and Local Authorities;
4. Law No. 96/12 of 5<sup>th</sup> August 1996 on the management of the environment;
5. Law No. 2025/012 of 17 December, 2025 bearing on the Finance Law of the Republic of Cameroon for the 2026 Financial Year
6. Law No. 2019/024 of December, 2019 on the General Code of Decentralized Territorial Communities.
7. Decree No. 2013/159 of 15 May, 2013 putting in place a special regime on Administrative Control of Public Finances
8. Law No 2016/017 of 14 December 2016 instituting the Mining Code;
9. Decree No. 2018/366 of 20<sup>th</sup> June 2018 to institute the Public Contracts Code and its texts of application;
10. Decree No. 2018/4992/PM of 21 June, 2018 putting in place the General Rules regulating the maturation of Public Investment projects;
11. Decree No. 2020/375 of 07 July, 2020 on the General Regulations of Public Accounting.
12. Instruments governing the various professional bodies;
13. Decree No. 2001/048 of 23<sup>rd</sup> February 2001 relating to the Setting up, Organization and Functioning of the Public Contracts Regulatory Agency
14. Decree No. 2003/651/PM of 16<sup>th</sup> April 2003 to lay down the Procedure for Implementing the Tax and Customs System applicable to Public Contracts;
15. Decree No. 2012/075 of 8<sup>th</sup> March 2012 to organise the Ministry in charge of Public Contracts;
16. Order No 212/A/MINMAP of September 28, 2021 organizing the operation of internal structures for the administrative management of Public contracts;
17. Order No. 000007/MINMAP of 01 January..... laying down the procedures for awarding and executing framework agreements
18. Order No. 168/A/MINMAP of August 11, 2021 setting the terms and conditions for the award and execution of design-build contracts;
19. Circular Letter No. 000010/LC/MINMAP/CAB of 22 September 2020, the clarifying the payment documents of the Administrative co-contractors to be submitted for visa prior to the Ministry in charge of Public Procurement
20. Order No. 001/CAB/PR of 19<sup>th</sup> June 2012 relating to the Award and Control of Execution of Public Contracts;
21. Letter No 00006/LC/PR/MINMAP/CAB of 17 August, 2021 clarifying the control of public procurement and specifying the procedures for its exercise to project owners and delegated project owners circular.
22. Law N° 2023/019 of 19/DEC/2023 instituting the 2026 Financial Law of the Republic of Cameroon
23. Circular No. 0001877/C/MINFI of 31<sup>st</sup> December, 2025 bearing instructions on the implementation of Finance Laws, Monitoring and Control of the Execution of the Budget of the State and Other Public Entities for the 2026 fiscal year ;
24. Circular No. 0001/PR/MINMAP/CAB of 25 April, 2022 relating to the application of the Public Procurement Code
25. Press Release No. 000024/R/MINMAP/CAB/CT2 of 5<sup>th</sup> August 2025 announcing the presentation of the categorization certificate in the award process of Public Contract
26. The MINCOMMERCE Decree setting the Price List

27. Order No 402/A/MINMAP/CAP of 21 October 2019 setting the nature and threshold of contracts reserved for craftsmen, small and medium-sized enterprises, grassroots communities and civil society organisations, and the modalities of their application;
28. Order No. 000333/O/MINMAP/CAB of 27<sup>th</sup> December 2024 to set the schedule of the migration to the exclusive award of Public Contracts<sup>111</sup> electronically
29. Circular letter No. 00000002/LC/MINMAP/CAB of 12 May 2022 relating to the continuity of the public procurement service in the event of a sanction by a Project Owner or Delegated Project Owners or members of a commission public procurement in accordance with the provision of articles 195 of the code of public contracts.
30. Circular No. 000014/C/MINMAP/CAB of 23<sup>rd</sup> July 2025 on the condition for constitution, guarantee, preservation, release, restitution, and realisation of guarantees in Public Contract
31. Unified Technical Documents (DTU) for building works;
32. Applicable standards;
33. Other instruments specific to the domain concerned with the Contract.

**Article 7: Communication (Articles 6 and 10 supplemented)**

7.1 All notifications and written communication within the framework of this Contract shall be sent to the following address:

- a) In the case where the contractor is the addressee: beyond the time-limit of 15 days fixed in Article 6 (1) of the GAC to make his domicile known to the Contract Manager and immediately after completion of the works, correspondences shall be validly address to council where the Contractor Resides.
- b) In case where the Contracting Authority is the addressee: correspondences shall be addressed to: The President of the North West Regional Assembly with copies addressed to the Contract Manager, the Engineer and the Regional Delegation of Public Contract North West.

7.2 The contractor shall address all written notifications or correspondences to the Engineer with a copy to the Contract Manager and the Regional Delegation of Public Contract North West.

**Article 8: Administrative Orders (Article 8 of GAC)**

The various Administrative Orders shall be established and notified as follows:

- 8.1 The Administrative Order to start execution of works shall be signed by the Contracting Authority and notified to the Contractor by the Contract Manager with a copy to the Contracting Authority, the Regional Delegation of Public Contract North West, the Contract Engineer and the Paying Body, where applicable.
- 8.2 Upon proposal by the Contract Manager, Administrative Orders with an incidence on the objective, the amount and execution deadline shall be signed by Contracting Authority and notified by the Contract Manager to the Contractor with a copy to the Contracting Authority, the Regional Delegation of Public Contract North West, the Contract Engineer, and the Paying Body. The prior endorsement of the Paying Body shall possibly be required before the signature of those that have an incidence on the amount.
- 8.3 Administrative Orders of a technical nature linked to the normal progress of the work and without financial incidence shall be signed directly by Contract Manager and notified to the Contractor by the Contract Engineer or Project Manager (where applicable) with a copy to the Contracting Authority, the Regional Delegation of Public Contract North West and Contract Manager.
- 8.4 Administrative Orders serving as warnings shall be signed by the Contracting Authority and notified to the Contractor by the Contract Engineer with a copy to the Contract Manager, the Regional Delegation of Public Contract North West.
- 8.5 Administrative Orders for suspension or resumption of work as a result of the weather or any other case of force majeure shall be signed by the Contracting Authority and notified by the Contract Engineer to the Contractor with a copy to the Contract Manager the Regional Delegation of Public Contract North West.

- 8.6 Administrative Orders prescribing works necessary to remedy disorders which could appear on structures during the guarantee period and not related to normal usage shall be signed by the Contract Manager upon the proposal of the Contract Engineer and notified to the Contractor by the Contract Engineer.
- 8.7 The Contractor has a time-limit of fifteen (15) days to issue reservations on any Administrative Order received. Having reservations shall not free the enterprise of executing the Administrative Orders received.
- 8.8 Concerning Administrative Order signed by the Contracting Authority and notified by the Contract Manager, the notification must be done within a **maximum of 30 days** from the date of transmission by the Contracting Authority to the Contract Manager. **Beyond this deadline, the Contracting Authority shall establish the default of the Contract Manager, take over from him and carry out the said notification.**

**Article 9: Contracts with conditional phases (Article 9 of GAC) (Not applicable)**

- 9.1 This Contract has only one phase for 2026 financial year. At the end of phase one, the Project Owner shall carry out the acceptance of the works and issue an attestation of proper execution to the Contractor. This attestation shall condition the start of the following conditional phase.
- 9.2 The time-limit granted for notification of the Administrative Order to start execution of a conditional phase shall be five (5) days.

**Article 10: Contractor's equipment and personnel (Article 15 of GAC supplemented)**

- 10.1 Any modification, even partial, made on the technical bid shall only occur after the written approval of the Contract Manager. In case of modification, the personnel replaced shall be a member of staff of equal competence (qualifications and experiences).
- 10.2 In any case, the lists of supervisory staff to be used shall be subject to the approval of the Project Owner in the days following notification of the Administrative Order to start execution. The contract Manager has **5 (five) days** to notify his opinion in writing with a copy sent to the Contract Engineer. Beyond this time-limit, the staff list shall be considered as approved.
- 10.3 Any unilateral modification on the supervisory staff made in the technical bid prior to and during the works shall be a reason for termination of the Contract as mentioned in article 45 below or the application of penalties.

## **CHAPTER II: FINANCIAL CONDITIONS**

**Article 11 Guarantees and bonds (Articles 29 and 41 of GAC)**

***11.1 Final bond***

The final bond shall be set at 2 % of the amount of the Contract, inclusive of all taxes.

It is constituted and transmitted to the Contract Manager within a maximum **deadline of twenty (20) days** of the notification of the Contract. It must also have a CDEC receipt or proof of deposit of the amount of the final bond requested into the Deposit and Guarantee Fund.

The bond shall be returned or the guarantee released within one month following the date of provisional acceptance of the works, following a release issued by the Contracting Authority upon request by the Contractor.

***11.2 Performance bond***

The retention fund shall be set at 10 % of the amount of the Contract, inclusive of all taxes.

The return or release of the retention fund or security shall be done within one month after final acceptance by release issued by the **Contracting Authority** upon request by the Contractor.

If cautioned, the Performance bond must also have a CDEC receipt or proof of deposit of the amount of the Performance bond into the Deposit and Guarantee Fund

### **11.3 Guarantee of start-off advance**

The contractor may be granted a start off amount of 20% of the contract amount (inclusive of taxes) upon request.

The start-off payment shall be guaranteed at 100% by a Cameroonian bank recognized by the Ministry in charge of Finance.

The Guarantee of start-off advance must have a CDEC receipt showing the deposit of the amount of the Guarantee of start-off advance into the Deposit and Guarantee Fund.

### **Article 12: Amount of the Contract (Articles 18 and 19 of GAC supplemented)**

The amount of this Contract as indicated by the attached [*detail or estimates*] is \_\_\_\_\_ (in figures) \_\_\_\_\_ (in letters) CFA francs Inclusive of All Taxes; that is:

- Amount exclusive of VAT: \_\_\_\_\_ (\_\_\_\_\_) CFA F
- Amount of VAT: \_\_\_\_\_ (\_\_\_\_\_) CFA F.
- Amount of TSR and/or \_\_\_\_\_ CFA F
- Net to be paid= EVAT-TSR and/or AIR

### **Article 13: Place and method of payment**

The Project Owner shall release the sums due in the following manner:

- a. For payments in CFA francs (*amount in figures and letters exclusive of taxes*) by credit to account No. \_\_\_\_\_ opened in the name of the Contractor in the \_\_\_\_\_ bank.
- b. For payments in foreign currencies (*amount in figures and letters exclusive of taxes*) by credit to account N<sup>o</sup>. \_\_\_\_\_ opened in the name of the Contractor in \_\_\_\_\_ bank.

### **Article 14: Price variation (Article 20 of GAC)**

33.1 Prices shall be firm.

- a. Payments on account made to the Contractor as advances shall not be revisable.
- b. Revision shall be "frozen" upon expiry of the Contractual time-limit, except in the case of price reductions.

33.2 Price updating modalities (Not applicable)

### **Article 15: Price revision formulae (article 21 of GAC)**

(Not applicable)

### **Article 16: Price updating formulae (article 21 of the GAC)**

(Not applicable)

### **Article 17: Works under State supervision (Article 22 of GAC supplemented)**

17.1 The percentage of works under State supervision shall *not exceed 2%* of the amount of the Contract and its additional clauses, where applicable.

17.2 In the case where the Contractor were invited to execute works under State supervision, the submitted and duly justified expenditures shall be reimbursed to him under the following conditions:

- The quantities considered shall be the hours used or the quantities of building materials and materials used that was the subject of joint job cost sheets;
- The remunerations and salaries effectively paid to local labour shall be increased by forty percent (40 %) to take account of social benefits;
- The hours put in by the heavy equipment shall be counted at the rate featuring in the sub-detail of prices;
- building materials and materials shall be reimbursed at cost price duly justified at the place of use, marked up by ten percent for loss, stocking and handling;

The amount for services thus calculated, including the hours put by heavy equipment shall be marked up by 25 % to take into account the overheads, profits and the Contractor's unforeseen.

### **Article 18: Evaluation of works (article 23 of the GAC)**

The work done shall be evaluated using the unit price.

**Article 19: Evaluation of supplies (article 24 of the GAC supplemented)**

19.1 *[Indicate, where applicable, the modalities for payment of supplies].*

19.2 No security shall be requested for payments on account on supplies.

**Article 20: Advances (article 28 of the GAC)**

20.1 The Contracting Authority *may* grant a start-off advance *equal to 20 % of the amount of the Contract.*

20.2 This advance whose value cannot exceed twenty (20) percent of the initial amount inclusive of all taxes shall be guaranteed at one hundred (100) percent by a financial establishment governed by Cameroon law or a first-rate financial institution in accordance with the instruments in force and reimbursed by deduction of the payments on accounts to be paid to the Contractor during the execution of the Contract according to the modalities laid down in the Special Administrative Conditions.

20.3 The total amount of the advance must be reimbursed not later than when the value in basic price of the works reaches eighty (80) percent of the amount of the Contract.

20.4 As the reimbursement advances, the Project Owner shall issue the release of the corresponding part of the guarantee upon the express request by the Contractor.

20.5 The possibility of granting start-off advance or advance for supplies must be expressly stipulated in the Tender File.

**Article 21: Payment for works (articles 26, 27 and 30 of the GAC supplemented)**

**21.1 Establishment of works executed**

*Before the 30<sup>th</sup> of each month, the Contractor and the Project Manager shall jointly establish a job cost sheet which summarises and fixes the quantities executed and established for each item on the schedule during the month and capable of giving entitlement to payment.*

**21.2 Monthly detailed account**

*No later than the fifth (5<sup>th</sup>) of the month following the month of the services, the Contractor shall hand over to the Project Manager two draft provisional monthly detailed accounts in seven copies (one detailed account exclusive of VAT and the other inclusive of taxes), according to the agreed model and establishing the total amount of the sums to which he may lay claim as a result of the execution of the Contract since the start of the Contract.*

*Only the detailed account exclusive of VAT shall be paid to the Contractor. The detailed account of the amount of the taxes shall be the subject of an entry into the budgets of the Ministry in charge of Finance*

*Only the amount exclusive of VAT shall be paid to the Contractor as follows:*

- 100-2.2 or 5.5% paid directly into the account of the Contractor;
- 2.2 Or 5.5 % paid to the Public treasury as AIR due by the Contractor.

*The amount of payment on account shall not exceed the value of the technical execution phases carried out. Payment on account may be spread over the duration of the execution of the Contract according to technical execution phases as defined in the Contract.*

*Payment on account shall take place within thirty (30) days from the date of transmission to the competent accounting officer, of the documents giving entitlement to payment.*

*The contractor shall transmit seven (7) copies of the partial invoices to the Engineer for approval before the 5<sup>th</sup> of the month following the works executed.*

*The Engineer shall within a time-limit of seven (7) days forward the approved partial invoices to the Chief of Service.*

*The Chief of Service has a maximum time-limit of twenty-one (21) days to sign the partial invoice and to produce the documents giving entitlement to payment on account and transmit same to the competent accounting officer.*

**21.3 Detailed account of start-off account (specify).**

**Article 22: Interest on overdue payments (Article 31 of the GAC)**

Possible interests on overdue payments are paid by statement of sums due in accordance with Decree No. 2018/366 of 20 June 2018 to institute the Public Contracts Code.

## **Article 23: Penalties (Article 32 of the GAC supplemented)**

### **A. Penalties for delay**

23.1 The amount set for penalties for delays shall be set as follows:

- a) One two thousandth ( $1/2000^{\text{th}}$ ) of the initial Contract amount all taxes inclusive per calendar day of delay from the first to the 30<sup>th</sup> day beyond the Contractual time-limit;
- b) One thousandth ( $1/1000^{\text{th}}$ ) of the initial amount of the Contract inclusive of all taxes per calendar day beyond the 30<sup>th</sup> day.

23.2 The cumulated amounts of penalties for delay shall be limited to ten percent (10 %) of the initial Contract inclusive of all taxes.

### **B. Specific penalties**

23.3 Independently of penalties for overrun of Contractual time-limit, the Contractor shall be liable for the following special penalties for the non-observation of the provisions of the Contract, especially:

- Late submission of final bond;
- Late submission of insurances, shall be one five thousandth ( $1/5000^{\text{th}}$ ) of the initial Contract amount all taxes inclusive per calendar day of delay from the first to the 30<sup>th</sup> day beyond the Contractual time-limit;
- Late submission of the draft execution schedule if the lateness is caused by the Contractor shall be one five thousandth ( $1/5000^{\text{th}}$ ) of the initial Contract amount all taxes inclusive per calendar day of delay from the first to the 30<sup>th</sup> day beyond the Contractual time-limit;

## **Article 24: Payment in case of a group of enterprises (article 33 of the GAC)**

1. In the case of a group of enterprises, indicate the method of payment of co- and sub-Contractors, where need be.
2. Indicate the method of payment of sub-Contractors, where need be.

## **Article 25: Final detailed account (article 34 of the GAC)**

25.1 After completion of the works and within a maximum time-limit of fourteen (14) days after the date of provisional acceptance, the Contractor shall establish, based on joint reports, the draft final detailed account of works executed and which detailed account summarises the total sums to which the Contractor may be entitled as a result of the execution of the whole Contract.

25.2 *The Contract Engineer has up to thirty (30) days to notify the corrected and approved draft to the Project owner.*

25.3 *The Contractor has up to thirty (30) days to return the corrected and approved final detailed account to the competent accounting officer.*

## **Article 26: General and final detailed account (article 35 of the GAC)**

26.1 The Contract Manager or the Project Manager has up to thirty (30) days to *establish the general detailed account and forward to the Contractor after final acceptance.*

At the end of the guarantee period which results in the final acceptance of the works, the Authorising Officer draws up the general and final detailed accounts of the Contract which he had signed jointly by the Contractor and the Contracting Authority. This detailed account includes:

- the final detailed account,
- the balance
- the summary of monthly payments on account.

The signing of the general and final detailed account without reservation by the Contractor definitely binds the two parties, puts an end to the Contract, except with regard to interest on overdue payments.

26.2 The Contractor has up to thirty (30) days to return the signed final detailed account.

## **Article 27: Tax and customs regulations (article 36 of the GAC)**

Decree No. 2003/651/PM of 16 April 2003 lays down the Terms and Conditions for Implementing the Tax regulations and Customs Procedures applicable to Public Contracts. The taxes applicable to this Contract include notably:

- Taxes and dues relating to industrial and commercial profits, including the IAR which is a deduction on company taxes;
- Registration dues in accordance with the Tax Code;
- Dues and taxes attached to the execution of services provided for in the Contract;
  - o Duties and taxes of entry into Cameroonian territory (customs duties, VAT, computer tax);
  - o Council dues and taxes;
  - o Dues and taxes relating to the extraction of building materials and water.

These elements must be included in the costs which the undertaking imputes on its running costs and constitute one of the elements of the sub-details of prices exclusive of taxes.

All taxes inclusive prices means VAT included.

**Article 28: Stamp duty and registration of Contracts (article 37 of GAC)**

Seven (7) original copies of the Contract shall be stamped by and at the cost of the Contractor, in accordance with the applicable regulations.

### **CHAPTER III: EXECUTION OF WORKS**

**Article 29: Nature of the works (article 46 of GAC)**

The works shall include especially: (position or volume of works)  
(*cf. Special Technical Conditions*)

**Article 30: Roles and responsibilities of the Project Owner (GAC supplemented)**

30.1 The Project Owner shall be bound to furnish the Contractor with information necessary for the execution of his mission and to guarantee, at the cost of the Contractor, access to sites of projects.

30.2 The Project Owner shall ensure the Contractor of protection against threats, insults, violence, assault and battery, slander or defamation of which he could be victim by reason of or during the exercise of his mission.

**Article 31: Execution time-limit of the Contract (article 38 of the GAC)**

31.1 The time-limit for the execution of the works forming the subject of this Contract shall be **Four (04) Months**.

31.2 This time-limit shall run from the date of notification of the Administrative Order to commence execution of the works.

**Article 32: Roles and responsibilities of the Contractor (article 40 of the CAG)**

The detailed and general plan of progress of the works shall be communicated to the Contract Engineer in *five (05)* copies at the beginning of each.

**Article 33: Provision of documents and site (article 42 of the GAC)**

A reproducible copy of the plans featuring in the Tender File shall be submitted by *the Contract Engineer*. The Project Owner shall make available the site and access ways to the Contractor at the appropriate time as the works progress.

**Article 34: Insurance of structures and civil liabilities (article 45 of GAC)**

The Contractor shall take out a third party risk insurance concerning persons, property or liabilities from an insurance company governed by the "CIMA" insurance code.

**Article 35: Documents to be furnished by the Contractor (Article 49 of the GAC supplemented)**

35.1 **Programme of works, Quality Assurance Plan and pegging map.**

a) Within a maximum deadline of *fifteen (15) days* from the date of notification of the Administrative Order to commence execution, the Contractor shall submit in *six (6)* copies for the approval of *project owner after the endorsement of the Contract Engineer* the execution programme of the works, his supply calendar,

his draft Quality Assurance Plan and the Environment Management Plan, where applicable and the electricity network pegging map at scale 1/2500.

This programme shall be exclusively presented according to the furnished models.

Two (2) copies of these documents will be returned to him within a deadline of fifteen (15) days from the date of reception with:

- Either the indication "GOOD FOR EXECUTION";
- Or the indication of their rejection including the reasons for the said rejection.

The Contractor has eight (8) days to present a new draft. The Contract Manager or the Project Manager then has a deadline of five (5) days to give his approval or possibly make comments. Delay in approving the draft execution schedule shall stay the execution deadline.

The approval given by the Project Owner does not in any way release the Contractor of his responsibilities. Meanwhile, works executed before the approval of the programme shall neither be ascertained nor paid for. The updated and approved schedule will become the Contractual schedule.

The Contractor shall constantly update on site, a schedule that will take account of real progress of the site. Significant modifications may only be made on the Contractual programme upon receiving the approval of the Project engineer. After approval of the execution schedule by the Contract Manager, the latter shall transmit it within five (5) days to the Contracting Authority without staying its execution. However, if important modifications alter the objective of the Contract or the nature of the works, the Contracting Authority shall return the execution schedule accompanied by reservations to be lifted within fifteen (15) days of the date of reception.

- a) The Environment Management Plan should bring out notably the choice technical conditions of the site and basic life, conditions of the backfill of the extraction sites and conditions for reinstating the works and installation sites.
- b) The Contractor shall indicate in this schedule the equipment and methods which he intends to use as well as the personnel he intends to employ.
- c) The approval granted by the Contract Engineer shall in no way diminish the responsibility of the Contractor with regard to the harmful consequences which their implementation may cause both towards third parties and the respect of clauses of the Contract.

### **35.2 Execution draft**

a) The execution plan documents (calculations and drawings) necessary for the realisation of all the parts of the structure must be submitted for the endorsement of the Contract Engineer at most fifteen (15) days prior to the date provided for the commencement of execution of the corresponding part of the structure.

b) The Contract Engineer has a deadline of *five (05) days* to examine and make known his observations. The Contractor then has a deadline of (04) four *days* to present a new file including the said observations.

35.3 In case of the non-observance of the approval deadlines of the above documents by the Administration, these documents shall be deemed to have been approved.

### **Article 36: Organisation and safety of sites (article 50 of the GAC)**

36.1 Signboards at the beginning and end of each section must be placed within a maximum deadline of fifteen days after the notification of the Administrative Order to commence work. It must have the following characteristics: Height = 2.80m, width=1.20m, board thickness=2.5cm at 1.20m above the ground level. The Contract Engineer shall put at the Contractors' disposal the text to be used.

36.2 The services to inform in case of interruption of traffic or along the deviated itinerary: *[To be specified in accordance with article 50(2) of the GAC]*.

36.3 Indicate the special measures demanded of the Contractor, other than those provided for in the GAC, for rules of hygiene and safety and for circulation around or in the site.

### **Article 37: Implantation of structures**

The Project Owner shall notify within [five] days following the date of notification of the Administrative Order to commence work, the basic points and levels of the project.

**Article 38: Sub-Contracting (article 54 of the GAC)**

The part of the works to be sub-Contracted shall not exceed 30 % of the initial amount of the Contract and its additional clauses.

**Article 39: Site laboratory and trials (article 55 of GAC)**

39.1 Indicate if necessary the modalities for carrying out the trials and geotechnical studies provided for in the Special Technical Conditions.

39.2 The Contract Manager has a deadline of three days to approve the Contractor’s personnel and laboratory as soon as the request is made.

**Article 40: Site logbook (article 56 of the GAC supplemented)**

40.1 The Site logbook must be systematically jointly signed by the Project Manager or Engineer, where need be and the Contractor’s representative each day.

40.2 It is a joint document in a single copy. Its pages must be numbered and initialled. No page should be removed. The erased or cancelled parts must be mentioned on the margin for validation.

**Article 41: Use of explosives (article 60 of the GAC) (specify)**

**CHAPTER IV : ACCEPTANCE**

**Article 42: PROVISIONAL ACCEPTANCE**

**42.1 PRE-ACCEPTANCE OPERATIONS**

Before the acceptance of the works the Contractor shall ask in writing to the Contract Engineer, to organize a technical visit for pre-acceptance. This visit shall include the following operations.

- Qualitative and quantitative evaluations of the different works that have been executed.
- Findings and statement of the unexecuted task envisaged in the present contract.
- Findings relative to the completion of the work
- Findings on the quantity of works that have been effectively realized

These operations shall be subject to a site report drawn up on the field, signed by the following.

- Contract Engineer;
- The Contract Manager
- RD/MINMAP/NW (Observer);
- The Director of the hospital;
- Contractor.

During this pre-reception, the Engineer shall eventually specify the reserves to be lifted and the corresponding works to be effected before the reception. The Engineer shall fix the reception date in collaboration with the Contract Manager.

**42.2 Acceptance**

The acceptance commission shall comprise:

- 1- The President of the North West Regional Assembly or his representative ..... (Chairman)
- 2- The Contract Manager or his representative ..... (Member)
- 3- The Contract Engineer ..... (Secretary)
- 4- The Stores Accountant of North West Regional Assembly..... (Member)
- 5- The RD MINMAP/NW or his representative ..... (Observer)
- 6- The Beneficiary..... (Observer)
- 7- The Commissioner incharge of Health at the North West Regional Assembly..... (Observer)
- 8- The Contractor or his Representative..... (Observer)

**The commission shall examine the report of the pre-acceptance including a video from the Contractor showing the stages of works executed. This shall proceed with the acceptance.** An acceptance report (process - verbal) of the works shall be prepared by the Contract Engineer and signed by at least 2/3 of the commission members.

#### **ARTICLE 43: DOCUMENTS TO BE FURNISHED AFTER EXECUTION**

43.1 The contractor shall furnish within one (1) month after completion of the works five (5) copies of all working documents and drawings as executed, especially those relevant to the exploitation and maintenance of the works.

43.2 A penalty of 30% of the guarantee retention shall be retained in the event where the contractor fails to comply with Article 43.1 above.

#### **Article 44: GUARANTEE PERIOD.**

The guarantee period is one (01) year from the date of the provisional acceptance.

#### **Article 45: Final acceptance (article 72 of the GAC)**

Final acceptance shall take place within a maximum deadline of fifteen (15) days from the date of expiry of the guarantee.

The procedure for final acceptance shall be the same as for provisional acceptance

### **CHAPTER V: SUNDRY PROVISIONS**

#### **Article 46: Termination of the Contract (article 74 of the GAC)**

The Contract may be terminated as provided for in Decree No. 2018/366 of 20 June 2018 and equally under the conditions laid down in articles 74, 75 and 76 of the GAC especially in one of the following cases:

- Delay of more than fifteen (15) calendar days in the execution of an Administrative Order or unjustified stoppage of more than seven (7) calendar days;
- Delay in work resulting in penalties of more than 10 % of the amount of the works;
- Refusal to repeat poorly executed works;
- Default by the Contractor;
- Persistent non-payment for services.

#### **Article 47: Case of force majeure (article 75 of the GAC)**

If the Contractor were to raise the issue of force majeure, the thresholds below which claims shall not be admitted are:

- *Rainfall: 200 millimetres in 24 hours;*
- *Wind: 40 metres per second;*
- *Flood: decennial flood frequency.*

#### **Article 48: Disagreements and disputes (article 79 of the GAC)**

Disagreements and disputes resulting from the execution of this Contract may be settled amicably.

Where no amicable solution can be found for a disagreement, it is brought before *the competent court in the North-West Region of the Republic of Cameroon.*

#### **Article 49: Production and dissemination of this Contract**

*Twenty (20)]* copies of this Contract shall be produced at the cost of the Contractor and furnished to the Contract Manager.

#### **Article 50 and last: Entry into force of the Contract**

This Contract shall be final only upon its signature by the Contracting Authority. It shall enter into force as soon as it is notified to the Contractor by the Contracting Authority.

**Document N°. 5**  
**SPECIAL TECHNICAL CONDITIONS**  
**(STC)**

## **SPECIAL TECHNICAL SPECIFICATIONS (STS)**

### **SPECIAL TECHNICAL SPECIFICATIONS (STS) FOR THE CONSTRUCTION OF A theatre block AT NKWEN DISTRICT HOSPITAL.**

The works that will constitute the construction works for the CONSTRUCTION OF A THEATRE BLOCK AT NKWEN DISTRICT HOSPITAL. PHASE II will involve the following tasks:

Preliminary works shall include:

- The work shall consist of mobilization of equipment to and from the site, construction of site offices and drawing up of the performance programme, layout plans and drawings.
- Demolitions and Implantation of the new building.

After preliminary works have been performed on the site, the supervisor will during a detailed visit state to the contractor, the work to be performed.

This visit will be the subject of a report to be signed by the Project team and the contractor.

### **PERFORMANCE PROGRAMME**

The Contractor shall provide a performance programme and a work schedule which should be followed up daily and especially updated after precise definition of works in accordance with the performance documents.

## **II – TECHNICAL SPECIFICATION OF WORKS**

### **1. REINFORCED CONCRETE:**

#### **GENERAL**

Unless otherwise specified herein concrete works shall conform to the standard requirements of civil engineering practise

#### **MATERIALS**

- Cement for the Concrete shall conform to the requirements of specifications for the Artificial Portland cement (CPA 325).
- Water used in mixing block work or concrete shall be clean and free from any other injurious amounts of oils, acids, alkaline, organic materials or other substances that may be deleterious to concrete or steel.
- Sand: Fine aggregates shall consist of hard, tough, durable and uncoated particles. The shape of the particles shall be generally rounded or cubicle and reasonably free from flat or elongated particles. The stipulated percentages of fines in the sand shall be obtained either by the processing of natural sand or by the production of suitably graded manufactured quarry sand.
- Gravel: Course aggregate shall consist of, crushed gravel or rock; it shall be of hard, tough, durable, lean and uncoated particles.
- Reinforced Bars shall conform to the requirements of standard specifications for steel Bars for concrete reinforcement and to specification for minimum requirements for the deformed steel bars for concrete specifications.

All secondary ties such as stirrups, spirals and insets may be plain bars. The main reinforcing bars shall be as follows:

NO 1.	ϕ 6mm
NO 2.	ϕ 8mm
NO 3.	ϕ 10mm
NO 4.	ϕ 12mm
NO 4.	ϕ 14mm

The reinforcement must be tied form using binding wire. Do not superpose more than 3 bars by putting 1 on top of the other. Bars having the largest section must always be provided with hooks at their extremes

### PROPORTIONING AND MIXING OF CONCRETE

- Proportions of materials in 1m<sup>3</sup> of concrete shall be as follows

Class	Cement	Sand	Gravel	Use
A - 450Kg/m <sup>3</sup>	1	1	1	Retailing walls, concreting under water
B - 350Kg/m <sup>3</sup>	1	1	1.5	Footings, columns, beams & R.C. slabs
C - 250Kg/m <sup>3</sup>	1	2	2	Blinding concrete, slab

- All class of concrete shall have a 28-day strength of 2.5KN/m<sup>3</sup>, for all concrete work, except otherwise indicated on the plan.
- Mixing – concrete shall be machine mixed. Mixing shall begin within 30minutes after cement has been added to aggregates. In the absence of a concrete mixer, manual mixing is allowed on a clean slab and has to be approved by the engineer.

### FORMS

- Forms shall be used wherever necessary to confine the concrete and shaped it to the required lines to avoid the concrete from contamination with materials from the surroundings. Forms shall be of sufficient strength to withstand the pressure resulting from placement and vibration of the concrete, and shall be maintained rigidly in the correct position. Forms shall be sufficiently tight to prevent loss of mortar from the concrete, for forms exposed surfaces against which backfill is not to be placed shall be lined with a form grade plywood.
- Cleaning and oiling of forms – Before placing the concrete, the contact surfaces of the form shall be leaned of mortar, grout or other foreign materials, and shall be quoted with a commercial form oil that will effectively prevent sticking and will not stain the concrete surface.
- Removal of forms – Forms shall be removed in the manner, which will prevent damage to the concrete. Forms shall not be removed without approval. Any repairs of surface imperfections shall be performed at once and airing shall be started as soon as the surface is sufficiently hard.

### PLACING REINFORCEMENT

- **GENERAL** – Steel reinforcement shall be provided as indicated, together with all necessary wire ties, chairs, spacers, supporters and other devices necessary to install and secure the reinforcement properly. All reinforcement, when placed shall be free from loose, flaky rust and scale oil grease, clay and foreign substances that would reduce or destroy its bond with concrete. Reinforcement shall be placed accurately and secured in place by use of metal or concrete supports, spacers and ties. Such

supports shall be of sufficient strength to maintain the operation. The supports shall be used in such manner that they will not be exposed or contribute in any way to the deterioration of the concrete.

- **PLACING** – Concrete shall be vibrated into the corners and angles of the forms and around all reinforcements and embedded items without permitting the material to segregate. Concrete shall be deposited as close as possible to its final position in the forms so that flow within the mass does not exceed two (2) meters and consequent segregation is reduced to a minimum near forms or embedded items or elsewhere as directed, the discharge shall be so controlled that the concrete may be effectively compacted into horizontal layers not exceeding 30 centimetres in depth within the maximum, lateral movements specified.
- Time interval between mixing and placing concrete shall be placed before initial set has occurred and before it has contained its water content for more than 45 mins.
- **Consolidation of Concrete** – Concrete shall be consolidated with the aid of; mechanical vibration equipment and supplemented by hand spading and tamping vibrators shall not be inserted into the lower course that have commenced initial set and reinforcement embedded in concrete beginning to set or already set shall not be disturbed by vibrators. Consolidation around major embedded parts shall be by hand spading and tamping and vibration shall not be used.
- **Placing concrete through reinforcement** – In placing concrete through reinforcement, care shall be taken that no segregation of the coarse aggregate occurs. On the bottom of beams and slabs, where the congestion of steel near the forms makes placing difficult, a layer of mortar of the same cement sand ratios as used in concrete shall be first deposited to cover the surface

## **CURING**

- **GENERAL** – All concrete shall be moist cured for a period not less than 7 consecutive days by an approved method or combination applicable to local conditions.
- **Moist Curing** – The surface of the concrete shall be kept continuously wet by covering with plastic or other approved materials thoroughly saturated with water and keeping the covering by wet spraying or intermittent hosing.

## **FINISHING**

- Concrete surfaces shall not be plastered unless otherwise indicated. Exposed concrete surfaces shall be formed with plywood, and after removal of forms, the surfaces shall be smooth to line and shall present finished appearance except for minor defects which can easily be repaired by patching with cement mortar or can be grounded to a smooth surface to remove all joint marks of the form work.
- Concrete slabs on fill. The concrete slab on fill shall be laid on a prepared foundation consisting of sub grade and granular fill with thickness equal to the thickness of over laying slab except as indicated otherwise.

## **2. BLOCKWORKS**

### **MATERIALS**

- Concrete hollow blocks shall have a minimum face wall thickness of 20cm. Normal size shall be 20, 15, 10cm thick with height of 20cm and length of 40cm. All units shall be stored for a period of not less than 28days (including curing period) and shall not be delivered to the job site prior to that time unless the strength equal or exceed those mention in these specification.
- Wall reinforcement shall be No. 3 or 10mm steel bars.
- Sand shall be river sand, well screened, clean, hard, sharp siliceous, free from loam, silt or other

impurities, composed of grains of varying sizes within the following limits:

Sieve No	Passing/Retain	Percentage
9	Pass	100
16	Retained	5
100	Retained	7

- Cement shall be Artificial Portland cement, (APC 325)
- Mortar – Mix mortar from 3 – 5 mins in such quantities as needed for immediate use, re-tampering will be permitted if mortar stiffens because of premature setting. Discard such materials as well as those, which have not been used within 1hr after mixing.
- Proportioning: Cement mortar shall be one (1) part Portland cement and two (2) parts sand by volume but not more than one part Portland cement and three (3) parts sand by volume.

	Normal Proportion	Maximum Proportion
Cement	1	1
Sand	2	3

## ERECTION

- All masonry shall be laid plumb, true to line, with level and accurately spaced courses, and with each course breaking joint with the course below. Bond shall be kept plumb through out, corners shall be plumb and true. Units with greater than 12% absorption shall be wet for at least 2 hrs before laying. Work required to be built in with masonry, including anchors, wall plugs and accessories, shall be built as the erection progresses.
- Masonry Units – Each course shall be solidly bedded in Portland cement mortar. All horizontal and vertical points shall be completely filled with mortar and as laid, each course shall be bonded at corners and intersections. No cells shall be left open in face surfaces. All cells shall be filled up with mortar for exterior walls. Units terminating against beam or slab so fit shall be wedged tight with mortar. Do not lay cracked, broken or detached block.
- The block work shall be carried up in a uniform manner, no one portion being raised more than 1,2 m above another at one time.
- Lintels shall be of concrete and shall be enforced as shown on the drawings. Lintels shall have minimum depth of 20 cm and shall extend at least 20cm on each side of opening.

## MORTAR JOINTS :

- Mortar joints to block work generally shall be 10 mm in thickness.
- The joints in block work receiving plaster, tiling or similar finishing, shall be raked out whilst the mortar is soft to form key for the plaster or mortar backing. The depth of the raking out will depend on the condition of the blocks; the rougher the blocks on face the shallower the raking out and the smoother the blocks the deeper the raking out.

## 3. PLASTERING:

- Walls shall be well wetted before plastering is commenced.
- The surfaces of internal plaster shall be steel trowel led to a smooth, even and true finish. External plaster shall be finished to a true and even surface with a wood float. All plaster surfaces shall be free from blemish.
- Plaster shall be returned into reveals and soffits of openings, and all angles shall be true and straight

with salient angles slightly rounded.

- The Engineer shall approve the rendering coat of plaster in two-coat work before the setting coat is applied, and notice shall be given to the Engineer, when it is ready for inspection.
- All cracks, blisters and other defects shall be cut out and made good and the whole left perfect at completion.
- Plaster on walls shall be not less than 12 mm or more than 20 mm in thickness, and plaster on concrete ceilings and beams shall not be less than 9 mm or more than 16 mm in thickness, unless otherwise specified.

#### **SCAFFOLDING**

- Provide all scaffolding require for masonry work, including cleaning down on completion remove.

#### **4. FLOORING AND TILING**

##### **SCREED FLOOR:**

- Concrete sub-floors finished with wood mosaic, vinyl sheeting and tiles, and similar finishing shall be screeded with 3:1 cement mortar, of thickness required but in no case less than 12 mm, and steel trowelled to a true and smooth surface suitable to receive finishing's. Concrete sub floors finished with wood block and similar finishing, shall be similarly screeded but finished to a true and even surface with a wood float. The sand used in the mortar shall be of such fineness as will allow of the screed being trowelled to a surface suitable to receive the finishing.
- The screeding shall be laid before the concrete sub-floors have matured otherwise the exposed surfaces of concrete shall be thoroughly cleaned with a wire brush, and a coat of neat cement grout applied immediately before the screeding is laid.
- The screeding shall be laid in good time to allow of it being perfectly dry when the finishings are laid.
- No traffic shall pass over nor shall any building operations take place on the screeding without proper covering first being provided.

##### **VITRIFIED FLOOR TILE INSTALLATION**

- Do not start floor tiling in works that involve tilling both wall and floor, finish with wall tiles before starting the flooring
- Before spreading setting bed, establish borderline centre wires in both directions to permit laying pattern with minimum of cut tiles. Lay floors without borders from centreline outwards. Make adjustments at walls.
- Clean concrete sub floor and moisten it without soaking. Sprinkle dry cement over surface. Spread setting bed mortar on concrete and tamp to assure good bond over the entire area then screed to smooth level bed. Set average setting bed thickness at 15mm but never less than 12mm.

##### **WALL TILE INSTALLATION.**

- Scratch coat for application, as foundation coat shall be at most 12mm while still plastic, deeply scratch coat or scratch and cross scratch. Protect scratch coat and keep reasonably moist within seasoning periods. Use mortar for scratch, float coat, within 1hr after mixing. Tempering of partially hardened mortar is not permitted. Scratch coat shall be cured for at least 2 days before starting tilling.
- For last coat, use one part Portland cement, one part hydrated lime.
- The tiles shall alternatively be fixed directly to plastered walls with an adhesive approved by the Engineer or the tiles shall be fixed direct to walls in 3:1 cement mortar with horizontal and vertical joints continuous, and shall have all joints rubbed in solid with neat white cement grout. Tiles shall be well soaked in water before fixing and thoroughly cleaned off after fixing.

## 5. CARPENTRY AND JOINERY WORK

### MATERIAL

**QUALITY OF TIMBER:** Timber shall be of approved quality of the respective kind for the various part of the works, well seasoned, thoroughly dry, and free from large, loose, or unsound knots, saps, shakes and other imperfections impairing its strength durability or appearance. All finishing timber to be used shall be completely dried and shall not contain more than 14 % moisture. It may be of the following (Doussie, Maobi, Tali, Azobe, Iroko, Bibinga, Mahogany etc)

### TREATMENT OF THE TIMBER:

- All concealed timber shall be sprayed with solignum or its equivalent
- Surface in contact with masonry and concrete shall be coated with creosote or equivalent.
- All door/window sashes shall be well-seasoned, flush type or semi hollow core or solid core, plywood veneers on both sides. Exterior door shall be of dried panel doors

### KIND OF TIMBER

All unexposed timber for framing shall be of hard wood (mahogany, iroko, etc). All window and doorjambes shall be of hard wood Balcony railings, flooring, girder and joints shall be also of hard wood. All interior flooring shall be of well-seasoned mahogany. Living room wood panels at the second floor shall be of plywood. Eaves shall be of seasoned white wood or Bac Alu. Exterior sidings shall be seasoned sun dried V-cut white wood or Bac Alu.

## 6. ARCHITECTURAL FINISHES SCHEDULE:

### FLOORING

- Interior flooring may be normal or of vitrified tiles of 210 x 210mm
- Toilet floors shall be mosaic tiles.
- Balcony floors may be normal or of 210x210mm vitrified tiles

### WALLING

- All interior partitions shall be of 15cm thick block walls.
- Exterior walling shall be 20cm thick block work.
- Walls shall be plastered and given a good finish.
- Toilet wall finish shall be of 100x100mm ceramic tiles

### CEILINGS

- All interior ceiling shall be of strip ceiling
- Outside ceiling eaves shall be of strip ceiling, with air Vents covered with screen

### DOORS

- All interior, doors shall be hollow core flushed door using plywood veneer.
- All toilet doors shall have one side using waterproofed plywood facing inside. Bring float coat to flush with screed or temporary guide strips placed to the even surface at proper distance from the tile-finished face.
- Setting wall tiles; soak wall tiles thoroughly in clean water before setting. Set wall tile by trowelling neat Portland cement skim coat on the float coat or apply skim coat to back of each tile unit. Immediately float tile in place. Make joints straight, level and perpendicular. Maintain vertical joints plumb.

- Grouting: Grout joints in wall tile with neat white cement immediately after suitable area of tile has been set. Tool joints slightly concave, cut excess mortar and wipe from face tile. Roughen interstices of depressions in mortar joints after grout has been cleaned from surface. Make joints between wall tile, plumbing and other built in fixtures with light colored caulking. Immediately after grout has had its initial set, give the wall surfaces protective coat of non-corrosive soap.
- All exterior doors shall be solid panel doors or metallic

## **WINDOWS**

- All windows shall be wood casement.
- Other windows as indicated in the plan shall be glass jalousie.
- Glass and glazing: all windows shall be glazed on the outside with steel casement putty, glass shall be puttied and face-puttied in a neat trim line manner, with steel glazing chips.
- Provide louvers below the ceiling and wall partition of bedrooms without exterior window access.

## **FINISHING HARDWARE.**

- Butt hinges: unless otherwise approved, use brass, polished and finely finished, mortise ball bearing 5 knuckles, non-rising loose pins, Use one and one-half pairs (3) pairs of hinges per leaf of doors more than 1.80m high, loose pin butt for room doors, fixed pin butt for closed.
- Keying and keys; locks shall be keyed in sets and sub sets to provide maximum expansion. All sets shall be grand master and all entrance locks shall be great grand mastered keyed per unit.

RIM BOLTS: Rim bolts keeper shall be chrome finished.

DOOR BUMPERS: Where wooden doors shall strike an object during opening provide door bumper.

Cabine hinges shall be "Washington" type or plano hinges heavily chrome or nickel-plated.

Cabinet and closet catches shall be plastic roller types.

Provide yale door closers for all swing exterior doors. (Pivoted)

Provide heavy-duty head and foot bolt for the main entrance doors.

## *7. ROOFING*

### **MATERIALS:**

ROOF SHEATHING : shall be roofing corrugated aluminium according to standard specifications

### **INSTALLATION WORKMANSHIP:**

Sheathing – layout the roofing sheets in a manner that the side over lap faces away from the prevailing wind.

Provide adequate overlap on ends. Secure the roofing tiles/sheets to purlin by using hook on the tiles.

## *8. PLUMBING WORKS:*

### **GENERAL:**

All work shall be done under the direct supervision of a licensed plumber and in strict accordance with this specification and of the methods as prescribed.

### **MATERIALS:**

Diameters, of evacuation tube to be used in fitting.

Wash hand basin..... 32mm

Vitrified porcelain urinals ..... 40mm

Pool baths ..... 40mm

Taps ..... 32mm

Showers .....	40mm
Toilet seats .....	100mm
Collections & canalisation of rain water .....	100/125/200mm

**ALTERNATE MATERIALS:**

Alternate material allowed, provided such alternate as approved by engineer such as PVC pipes for sewer and drainage pipes.

Each length of pipe, fitting, fixture and device used in plumbing system shall have cast, stamped or indelibly marked on it, manufacturer's trademark.

**INSTALLATION:**

- Install plumbing fixtures as indicated on drawing, furnishing all bracket, cleats clip plates and anchors required supporting fixtures rigidly in place.
- Install all fixtures and accessories in locations directed in accordance with the manufacturer's instructions, minimizing pipe fittings.
- Protect items with approval means to maintain perfect conditions. remove work damaged or defective and replace with perfect item without extra cost to owner:
- All PVC soil drainage pipes shall have a minimum slope of 1%.
- Vertical pipes shall be secured strongly by hooks to building framing. Provide suitable bracket or chairs at the floors from which they start. Where an end or circuit vent pipe from any fixtures or line of fixture is connected to a vent line serving other fixtures, connection shall be at least 1.20m above floor on which fixtures are located, to prevent use of any vent line as a waste. Horizontal pipes shall be supported by well-secured strap hangers.
- Connection of water closets to soil pipes shall be made by means of flanged plates and asbestos packing without use of rubber putty or cement.

**ROUGH-IN**

- All items to be embedded in concrete shall be thoroughly clean and free from all rust, scale and paint.
- All changes in pipe sizes on soil, wash and drain shall be provided with reducing fittings or recess reducers.
- Plumber shall take high corrosive nature ground within site into account. Protective features shall be installed to prevent corrosion of all water pipes installed underground.
- Extend piping to all fixtures, outlets and equipment, from gate valves installed in the branch near the riser.
- All pipes shall be cut accurately to measurements, and worked onto place without springing or forcing.
- Care shall be taken as not to weaken structural portions of the building.

*9. ELECTRICAL WORKS*

**SCOPE OF WORK**

- The work consist of furnishing of all materials and labour, tolls and equipment and all necessary services to complete the electrical work ready for operation as shown in the drawings and specified as follows:
- Supply and installation of the main and sub-feeders from electrical panel boards up to service entrance.
- Supply and installation of electrical panel boards, gutters, pull box and accessories box as required.
- Supply of wiring devices porcelain receptacles, outlets, switches etc. complete with suitable cover

plates as per specifications.

- Supply and installation for all branch feeders' circuits from panel boards up to all outlets, switches, controls other loads; wiring as show in plan.
- Installation of all owners furnished material such as lighting fixtures and electrical control.
- Grounding system as per EE Code requirements.
- The contractor shall secure that all EE standards are respected

#### **CODES AND REGULATIONS :**

The electrical work shall be done in accordance with all the requirements from the latest issue Cameroon Electrical codes, with rules and regulations and ordinances of the local enforcing authorities and Requirements of the AES SONEL Company.

#### **DRAWINGS AND SPECIFICATION :**

- All installation shall be done in a competent manner and include all necessary works that may not be clearly indicated in the plans or schematic but necessary to attain the purpose or intent of the design scheme.
- The plane indicating the general lay out of the system and the location of outlets are diagrammatic, and may be adjusted as required by the Engineer before installation.
- The contractor shall record all accomplishments as work progresses in a set of records plan. Three (3) sets of drawing shall be duly signed and sealed by the supervisor-in charge of construction shall be submitted for the owners and Engineer's references and maintenance purposes.

#### **MATERIALS AND WORKMANSHIP.**

All materials to be supplied shall be new and of high quality. Materials shall be standard products from reputable manufactur

#### **TECHNICAL SPECIFICATIONS:**

- Power service 220 volts, single phase, and 3 wire solid neutral 50hertz.
- Wiring methods: all power and control wiring shall be in rigid mild steel conductor.
- Grounding: Panel boards, race ways, gutters, metallic conduits and other non-current carrying metal parts of equipment, heaters, motor frames, shall be provided with effective grounding connection to a grounded cold centre pipe.
- Main and branch feeders:
- Conductors and complete conduct systems shall be provided as shown in drawing and no change, in sizes shall be made without approval by the Engineer or his authorized representative.
- Panel Board:
- Furnish and installs the electrical panel-boards as shown in plan.
- Receptacles switches: Outlets:
  1. Provide as indicated in drawing, the switches and receptacles with proper cover plates: Switches shall be of the quiet-matic type, or approved equal.
  2. Receptacles shall be duplex with proper cover plates rated 10amp. Min 220vV.
  3. Lighting outlets at ceiling shall be provided with 100mm octagonal box. Using TW wire CHB in flexible conduit makes connection from fixture to boxes.

#### **LIGHT FIXTURES:**

- Lighting fixtures shall be furnished and installed by the contractor. Detail of fixture design when not

standard shall be shown in the Architectural Drawing.

- Fluorescent fixtures shall be complete set with lamps and ballast of high quality, Philips G. C. phallic or approved equal.

#### **WIRES AND CABLES:**

No wires shall be drawn into a raceway until it is complete with all necessary fitting, boxes supports. Connections shall be securely fastened such as not to loosen under vibration and normal strain. All connections splices shall be made with approved methods.

#### **10. APPLICATION:**

- Fire retardant chemicals must be applied by the fire Retardant applicator duly authorized by the fire retardant chemical manufacturer/blender and certified by the fire Code implementing agencies. The applicator and/or his men must follow good painting Practices using paintbrush, spray or rollers. They must conform to the following rate of application
- All wooden doors and stairs shall be treated with fire retardant at the rate of 3m<sup>2</sup> per gallon for class a flame spread rating or the three (3) coatings.
- All ceiling boards, panelling and all wooden structures of the building that are found along corridors, lobbies and kitchen shall be treated at the rate of 13.5m<sup>2</sup> per gallon or two (2) coating.
- All interior panelling, ceiling, floors, closets, cabinets and all other wooden components found in the interiors of the building shall be treated with fire retardant chemicals at the rate of 18.6m. I gallon or one coat.
- All other exterior wooden based component of the building such as sidings, fascia boards, eaves, etc. shall be treated with fire retardant at the rate of 13.5m<sup>2</sup> per gallon or two (2) coatings.

#### **11. GUARANTEE:**

- The contractor shall and hereby warrants that all fire retardation work executed under this section shall be free from defects of materials and workmanship for a period of five (5) years from the date of completion of application.
- The contractor further agrees to that he will at his own expense repair and replace all such defective work and all other works damage thereby which becomes defective during the term of this warranty.

#### **II. SOCIO-ECONOMIC IMPORTANCE**

If social marketing could be improve upon and more staff recruited, the package of activities (primary health care, medical services), will be enjoyed by all our population catchmen and even attract patients out of our area. However the effort that each and everyone have made to make things work is well appreciated specially on our EPI coverage and as well some indicators have had their coverage rate improved in recent time following the activities of DOW (curative consultation, ANC, FP, STIs including HIV testing...)

#### **III. PROTECTION OF THE ENVIRONMENT**

The entreprise that will be assigned to carry out the works will propose to the Contract Engineer, before the beginning of works, the place of his site installation and will request his authorization for site installation.

The site must be chosen outside of the sensitive zone, in order to limit the site clearing, limit erosion and to ease circulation. In line with the above the site must foresee an adequate drainage of waters on the whole surface. The maintenance areas and of washing should be concreted. These maintenance areas should have a slope toward a cesspool provided for the purpose and towards the inside of the platform in order to avoid the out-flow of the polluting products to the neighbourhood.

At the end the works, the entreprise will do all necessary works to restore the opened borrow pits. The enterprise shall fold all his material, and equipment. He shall demolish all stationary installation, as foundation,

support made of concrete or metallic, etc. in order to put back the site in its nearest initial state. No equipment nor materials shall be abandoned on the site, nor in the vicinity after the execution of all the works. Left-over materials are to be carried away and the site has to receive an adequate drainage in order to avoid all erosion as the case may be.

**Document N°. 6**  
**SCHEDULE OF UNIT PRICES**

## UNIT PRICE LIST FOR THE PROJECT

<b>UNIT PRICE SCHEDULE FOR THE CONSTRUCTION OF A THEATRE AT NKWEN DISTRICT HOSPITAL MAZAM DIVISION, NORTH WEST REGION. PHASE II</b>					
NO	DESIGNATION	UNIT	QTY	AMT IN FIGURE	AMT IN WORDS
<b>100</b>	<b>PRELIMINARY WORKS</b>				
103	Site installation	LS	1		
104	Work execution programme and As-Built plan	LS	1		
<b>SUB-TOTAL 100</b>					
<b>200</b>	<b>ELEVATION OF FIRST FLOOR</b>				
201	R.C dosed at 350 kg/m <sup>3</sup> for pillars in elevation	m <sup>3</sup>	9.36		
202	R.C dosed at 350 kg/m <sup>3</sup> for lintels across openings	m <sup>3</sup>	6.53		
203	Provide cement/sand blocks of (15 x 20 x 40 cm) blocks	m <sup>2</sup>	635.00		
204	R.C access ramps dosed at 350 kg/m <sup>3</sup>	m <sup>3</sup>	0		
205	R.C chain beams dosed at 350 kg/m <sup>3</sup>	m <sup>3</sup>	8.658		
207					
<b>SUB-TOTAL 400</b>					
<b>300</b>	<b>CARPENTARY AND JOINERY (ROOFING)</b>				
301	Provide and assemble rafters of 5x15cm (4m) including necessary treatment and mounting	m <sup>3</sup>	7.65		
302	Provide and nail Purlins of (5x8) 4m to receive roofing sheets	m <sup>3</sup>	4.65		
303	Noggings (4x4)cmx4m long	m <sup>2</sup>	315.46		
304	Supply and installation of 5mm plywood ceiling on noggings at 1.20 x 0.60 previously treated wood including ceiling battens and any suggestions	m <sup>2</sup>	315.46		
305	Supplying and fixing 6m tole bac 5/10th roofing sheets including	m <sup>2</sup>	354.00		

	fixing accessories				
306	Supplying and fixing ridge cap including any suggestions	ml	46.02		
307	Parapet wall all round the building with all accessories including gutters and drainage outlets of dia. 100	ml	90.00		
308	Insulation layer and water proofing of parapet and roof slabs of 5cm including plumbing outlets	ls	1.00		
	<b>SUB-TOTAL 500</b>				
<b>400</b>	<b>SECTION 14: PLUMBING SANITARY INSTALLATION</b>				
401	Provisional sum for connection for existing water supply network, including excavation , protection etc	FF	1		
402	Provisional sum for all piping works in PVC, including chiselling, making good, etc	FF	1		
403	Supply and fix standard WC complete, including accessories, etc	U	20		
405	Supply and fix wash hand basins complete, including accessories	U	15		
406	Supply and fix sanitary mirrors complete, including accessories, etc	U	20		
407	Supply and fix toilet roll holder complete, including accessories, etc	U	8		
408	Supply and fix soap dish stand complete, including accessories, etc	U	8		
411	Supply and fix fire extinguishers as on plans, including accessories, etc	U	2		
414	Plastic wheeled waste bin 240L	U	2		
	<b>SUB-TOTAL 400</b>				
<b>500</b>	<b>WOODEN AND METALLIC WORKS</b>				
501	Supply and installation of double wooden doors 170 x 220 cm including frames, cylinder locks, hinges and any suggestions	U	3		

502	Supply and installation of Wooden doors 90 x 220 cm including frames, cylinder locks, hinges and any suggestions	U	11		
502	Supply and installation of double Wooden doors 70 x 220 cm including frames, cylinder locks, hinges and any suggestions	U	8		
<b>SUB-TOTAL 700</b>					
<b>700</b>	<b>WINDOWS</b>				
701	Supply and installation of complete aluminium sliding window 220 x 120 cm with glass including matalic protector and any suggestions	U	9		
701	Supply and installation of complete aluminium sliding window 140 x 120 cm with glass including matalic protector and any suggestions	U	5		
703	Supply and installation of complete aluminium sliding window 80x80 cm with glass including matalic protector and any suggestions	U	8		
704	metalic and aluminum works on the ramp, stairs and walkway as on plans	ml	80		
<b>SUB-TOTAL 800</b>					
<b>800</b>	<b>ELECTRICAL WORKS</b>				
	<b>PROVIDE AND FIT THE FOLLOWING</b>				
802	Provisional sum for all cabling of the building, including chiselling, making good connection, for electricity, air conditioner, smoke detectors, and overhead fans etc	Ls	1		
804	Supply and installation of high grade LED fluorescent lamps	U	10		
805	Supply and installation of high grade TV connection	U	2		
806	Supply and installation of high grade 2X2 Round lamps & bulbs	U	20		
808	Junction box	U	4		

809	Single Phase fuse box	U	4		
810	Supply and fit 2P+T 16A power sockets including accessories, as on plans	U	30		
811	Supply and fit circuit-breakers P+N 16A SCHNEIDER , including accessories etc	U	3		
812	Supply and fit one way switches, complete with accessories , etc	U	30		
813	supply and installation of electrical cabinet for centralization of the security device including wiring, connection and all implementation constraints (LEGRAND or INGELEC brand or any brand of equivalent quality)	U	1		
814	Supply and installation of CO2 type fire extinguishers and various accessories or equivalent	u	2		
<b>SUB-TOTAL 900</b>					
<b>900</b>	<b>PLASTERING AND RENDERING</b>				
901	Provide and apply rendering on the entire external walls surface	m <sup>2</sup>	360		
902	Provide and apply plastering on the internal walls	m <sup>2</sup>	1,400.00		
<b>SUB- TOTAL 1000</b>					
<b>1000</b>	<b>FLOORING/TILING</b>				
1001	Supply and installation of 1st choice 40x40 floor tiles of varying grades and patterns for all floors with high slicking properties for rooms, acceses & terraces	m <sup>2</sup>	410.00		
1002	Supply and installation of graded & designed tiles 20 x 20 for operation 1 and 2 scrub room patient transfer room and toilet walls and floors	m <sup>2</sup>	168.00		
<b>SUB- TOTAL 1100</b>					
<b>1100</b>	<b>PAINTING</b>				
1101	Provide and apply two coats of pantex 1300 primer on the entire external walls	m <sup>2</sup>	360		

1102	Provide and apply two coats of water base pantex 800 primer paint on the entire internal walls	m <sup>2</sup>	1,400.00		
1103	Provide and apply two coats water base pantex 800 on the entire plywood ceiling	m <sup>2</sup>	486		
1104	Provide and apply oil paint on metallic and wooden works	m <sup>2</sup>	125		
			<b>SUB- TOTAL 1200</b>		
<b>1200</b>	<b>EXTERNAL WORKS</b>				
1203	Planting of enviromental friendly trees and Howers including communication signs & signaletics	u	30		
			<b>SUB- TOTAL 1300</b>		
			<b>AMOUNT WITHOUT TAXES</b>		
			<b>VAT(19.25%)</b>		
			<b>AIR(2.2%)</b>		
			<b>TOTAL AMOUNT TAX INCLUSIVE</b>		
			<b>NET AMOUNT TO BE PAID</b>		

**Document N°. 7**  
**BILL OF QUANTITIES AND ESTIMATES**

**BILL OF QUANTITIES FOR THE CONSTRUCTION OF A THEATRE AT  
NKWEN DISTRICT HOSPITAL MAZAM DIVISION, NORTH WEST  
REGION. PHASE II**

<b>NO</b>	<b>DESIGNATION</b>	<b>UNIT</b>	<b>QTY</b>	<b>UNIT PRICE</b>	<b>TOTAL PRICE</b>
<b>100</b>	<b>PRELIMINARY WORKS</b>				
101	Site installation	LS	1		
102	Work execution programme and As-Built plan	LS	1		
	<b>SUB-TOTAL 100</b>				
<b>200</b>	<b>ELEVATION OF FIRST FLOOR</b>				
201	R.C dosed at 350 kg/m <sup>3</sup> for pillars in elevation	m <sup>3</sup>	9.36		
202	R.C dosed at 350 kg/m <sup>3</sup> for lintels across openings	m <sup>3</sup>	6.53		
203	Provide cement/sand blocks of (15 x 20 x 40 cm) blocks	m <sup>2</sup>	635.00		
204	R.C access ramps dosed at 350 kg/m <sup>3</sup>	m <sup>3</sup>	0		
205	R.C chain beams dosed at 350 kg/m <sup>3</sup>	m <sup>3</sup>	8.658		
	<b>SUB-TOTAL 200</b>				
<b>300</b>	<b>CARPENTARY AND JOINERY (ROOFING)</b>				
301	Provide and assemble rafters of 5x15cm (4m) including necessary treatment and mounting	m <sup>3</sup>	7.65		
302	Provide and nail Purlins of (5x8) 4m to receive roofing sheets	m <sup>3</sup>	7.65		
303	Noggings (4x4)cmx4m long	m <sup>2</sup>	4.65		
304	Supply and installation of 5mm plywood ceiling on noggings at 1.20 x 0.60 previously treated wood including ceiling battens and any suggestions	m <sup>2</sup>	315.46		
305	Supplying and fixing 6m tole bac 5/10th roofing sheets including	m <sup>2</sup>	315.46		

	fixing accessories				
306	Supplying and fixing ridge cap including any suggestions	ml	46.02		
307	Parapet wall all round the building with all accessories including gutters and drainage outlets of dia. 100	ml	90.00		
308	Insulation layer and water proofing of parapet and roof slabs of 5cm including plumbing outlets	ls	1.00		
				<b>SUB-TOTAL 300</b>	
<b>400</b>	<b>SECTION 14: PLUMBING SANITARY INSTALLATION</b>				
401	Provisional sum for connection for existing water supply network, including excavation , protection etc	FF	1		
402	Provisional sum for all piping works in PVC, including chiselling, making good, etc	FF	1		
403	Supply and fix standard WC complete, including accessories, etc	U	20		
405	Supply and fix wash hand basins complete, including accessories	U	15		
406	Supply and fix sanitary mirrors complete, including accessories, etc	U	20		
407	Supply and fix toilet roll holder complete, including accessories, etc	U	8		
408	Supply and fix soap dish stand complete, including accessories, etc	U	8		
411	Supply and fix fire extinguishers as on plans, including accessories, etc	U	2		
414	Plastic wheeled waste bin 240L	U	2		
				<b>SUB-TOTAL 400</b>	
<b>500</b>	<b>WOODEN AND METALLIC WORKS</b>				

501	Supply and installation of double wooden doors 170 x 220 cm including frames, cylinder locks, hinges and any suggestions	U	3		
502	Supply and installation of Wooden doors 90 x 220 cm including frames, cylinder locks, hinges and any suggestions	U	11		
503	Supply and installation of double Wooden doors 70 x 220 cm including frames, cylinder locks, hinges and any suggestions	U	8		
<b>SUB-TOTAL 500</b>					
<b>600</b>	<b>WINDOWS</b>				
601	Supply and installation of complete aluminium sliding window 220 x 120 cm with glass including matalic protector and any suggestions	U	9		
602	Supply and installation of complete aluminium sliding window 140 x 120 cm with glass including matalic protector and any suggestions	U	5		
603	Supply and installation of complete aluminium sliding window 80x80 cm with glass including matalic protector and any suggestions	U	8		
604	metalic and aluminum works on the ramp, stairs and walkway as on plans	ml	80		
<b>SUB-TOTAL 600</b>					
<b>700</b>	<b>ELECTRICAL WORKS</b>				
	<b>PROVIDE AND FIT THE FOLLOWING</b>				
702	Provisional sum for all cabling of the building, including chiselling, making good connection, for electricity, air conditioner, smoke detectors, and overhead fans etc	Ls	1		

704	Supply and installation of high grade LED fluorescent lamps	U	10		
705	Supply and installation of high grade TV connection	U	2		
706	Supply and installation of high grade 2X2 Round lamps & bulbs	U	20		
708	Junction box	U	4		
709	Single Phase fuse box	U	4		
710	Supply and fit 2P+T 16A power sockets including accessories, as on plans	U	30		
711	Supply and fit circuit-breakers P+N 16A SCHNEIDER , including accessories etc	U	3		
712	Supply and fit one way switches, complete with accessories , etc	U	30		
713	supply and installation of electrical cabinet for centralization of the security device including wiring, connection and all implementation constraints (LEGRAND or INGELEC brand or any brand of equivalent quality)	U	1		
714	Supply and installation of CO2 type fire extinguishers and various accessories or equivalent	u	2		
<b>SUB-TOTAL 700</b>					
<b>800</b>	<b>PLASTERING AND RENDERING</b>				
801	Provide and apply rendering on the entire external walls surface	m <sup>2</sup>	360		
802	Provide and apply plastering on the internal walls	m <sup>2</sup>	1,400.00		
<b>SUB- TOTAL 800</b>					
<b>900</b>	<b>FLOORING/TILING</b>				
901	Supply and installation of 1st choice 40x40 floor tiles of varying grades and patterns for all floors with high slicking properties for rooms, acceses & terraces	m <sup>2</sup>	410.00		

902	Supply and installation of graded & designed tiles 20 x 20 for operation 1 and 2 scrub room patient transfer room and toilet walls and floors	m <sup>2</sup>	168.00		
			<b>SUB- TOTAL 900</b>		
<b>1000</b>	<b>PAINTING</b>				
1001	Provide and apply two coats of pantex 1300 primer on the entire external walls	m <sup>2</sup>	360		
1002	Provide and apply two coats of water base pantex 800 primer paint on the entire internal walls	m <sup>2</sup>	1,400.00		
1003	Provide and apply two coats water base pantex 800 on the entire plywood ceiling	m <sup>2</sup>	486		
1004	Provide and apply oil paint on metallic and wooden works	m <sup>2</sup>	125		
			<b>SUB- TOTAL 1000</b>		
<b>1100</b>	<b>EXTERNAL WORKS</b>				
1101	Planting of enviromental friendly trees and Howers including communication signs & signalctics	u	30		
			<b>SUB- TOTAL 1100</b>		
<b>AMOUNT WITHOUT TAXES</b>					
<b>VAT(19.25%)</b>					
<b>AIR(2.2%)</b>					
<b>TOTAL AMOUNT TAX INCLUSIVE</b>					
<b>NET AMOUNT TO BE PAID</b>					

**Document N°. 8**  
**SUB-DETAIL OF PRICES**

## SUBDETAILS OF PRICES

Price N° .....  
 Designation of work.....  
 Unit .....  
 Quantity .....  
 Daily output .....  
 Duration of execution .....

DESIGNATION :					
No	Daily out put		Total quantity	Unit	Duration of activity
<b>WORKMAN SHIP</b>	Category	No	Daily wage	Days break up	Amount
<b>TOTAL A</b>					
<b>EQUIPMENT /MECHINES</b>	Type	No	Daily rate	Days break up	Amount
<b>TOTAL B</b>					
<b>MATERIAL AND MISCELLANOUS</b>	Type	Un it	Unit cost	Quantity	Amount
<b>TOTAL C</b>					
<b>D</b>	<b>DIRECT TOTAL COST</b>			A+B+C	
<b>E</b>	<b>GENERAL SITE EXPENESES</b>			Dx%	
<b>F</b>	<b>GENERAL OFFICE EXPENSES</b>			Dx%	
<b>G</b>	<b>NET COST</b>			D+E+F	
<b>H</b>	<b>RISK + BENEFITS</b>			Gx%	
<b>P</b>	<b>TOTAL COST (HT)</b>			G+H	
<b>V</b>	<b>UNIT COST (HT)</b>			P/Q'TY	

REPUBLIC OF CAMEROON  
Peace-Work-Fatherland

NORTH-WEST REGIONAL ASSEMBLY

REGIONAL EXECUTIVE COUNCIL

PEACE-JUSTICE-UNITY-HARD WORK- SOLIDARITY



REPUBLIQUE DU CAMEROUN  
Paix-Travail-Patrie

ASSEMBLEE REGIONALE DU NORD-OUEST

CONSEIL EXECUTIF REGIONAL

PAIX-JUSTICE-UNITE-TRAVAIL-SOLIDARITE

**JOBGING ORDER N° \_\_\_\_\_ JO/MINDEVEL/NWRA/ITB/2026 OF ..... 2026**  
**AWARDED AFTER OPEN NATIONAL INVITATION TO TENDER N° \_\_\_\_\_**  
**/ONIT/NWRA/ITB/2026 OF \_\_\_ / \_\_\_ /2026 FOR THE PHASE II CONSTRUCTION AND**  
**COMPLETION OF A THEATRE BLOCK AT NKWEN DISTRICT HOSPITAL**  
**(RELAUNCH)**

Project Owner: THE PRESIDENT OF THE NORTH WEST REGIONAL ASSEMBLY

**HOLDER :**

P.O. Box \_\_\_\_\_, Tel: \_\_\_\_\_ Fax: \_\_\_\_\_

Business Registry N° \_\_\_\_\_ at

Taxpayer's No. \_\_\_\_\_

**SUBJECT:** Execution of \_\_\_\_\_ works;

**PLACE :** \_\_\_\_\_

**EXECUTION DEADLINE:** \_\_\_\_\_ (\_\_\_\_\_) months

**AMOUNT IN CFA F:**

IAT	
EVAT	
VAT (19.25%)	
AIR (Income tax) (2.2%)	
Net to be paid	

**FINANCING :** [indicate the source of financing]

**BUDGET HEAD :** [to be completed]

SUBSCRIBED ON: \_\_\_\_\_

SIGNED ON: \_\_\_\_\_

NOTIFIED ON: \_\_\_\_\_

REGISTERED ON: \_\_\_\_\_

**Between:**

The Government of the Republic of Cameroon, represented by The President of the North West Regional Assembly hereinafter referred to the "Contracting Authority"

**On the one hand,**

**And**

\_\_\_\_\_ (enterprise)  
P.O. Box \_\_\_\_\_ Tel: \_\_\_\_\_ Fax: \_\_\_\_\_  
Business Registry No. \_\_\_\_\_  
Taxpayer's No. \_\_\_\_\_

Represented by M \_\_\_\_\_, its General Manager, hereinafter referred to as the "Contractor"

**On the other hand,**

Agree on the following:

**Summary**

Part I: Special Administrative Conditions (SAC)

Part II: Special Technical Conditions (STC)

Part III: Schedule of Unit Prices (SUP)

Part IV: Details or Estimates

Page \_\_\_\_\_ and last of Contract N° \_\_\_\_\_ C /NWRA/ITB/2026 OF ..... 2026  
 AWARDED AFTER OPEN NATIONAL INVITATION TO TENDER No \_\_\_/ONIT/NWRA/ITB/2026 of  
 \_\_/\_\_/2026 FOR THE PHASE II CONSTRUCTION AND COMPLETION OF A THEATRE BLOCK AT  
 NKWEN DISTRICT HOSPITAL (RELAUNCH)

With \_\_\_\_\_,

For the execution of \_\_\_\_\_ works

EXECUTION DEADLINE \_\_\_\_\_ (\_\_\_\_\_) months

Amount of Contract in CFA F:

IAT	
EVAT	
VAT (19.25)	
AIR (2.2 or 5.5 %)	
Net to be paid	

<p><b>Read and accepted by the Contractor</b></p>   <p style="text-align: center;">(place of signature) _____ (date)</p>
<p><b>Signature of Contracting Authority</b></p>   <p style="text-align: center;">(place of signature) _____ (date)</p>
<p><b>Registration</b></p>   

**Document N°. 10**  
**FORMS AND MODELS TO BE USED BY**  
**BIDDERS**

## TABLE OF MODELS

- Annex N° 1: Model of declaration to Tender
- Annex N° 2: Model Bid
- Annex N° 3: Model Bid Bond
- Annex N° 4: Model Final Bond
- Annex N° 5: Model Retention fund (Guarantee Retention)
- Annex N° 6: Schedule framework
- Annex N° 7: Model attestation of site visit
- Annex N° 8: Model site visit report
- Annex N° 9: Model table of reference
- Annex N° 10: Model table of equipment

Annex N° 1: MODEL OF DECLARATION TO TENDER

DECLARATION OF THE INTENTION TO TENDER

I the undersigned, .....(indicate the name and capacity of signatory),  
Nationality .....Representing the ..... company or  
enterprise or group with head office at..... registered in the trade register  
of ..... Under the number .....

In my capacity as .....of .....  
PO box ....., hereby acknowledge receipt of the file for Open National Invitation to Tender  
N° ..... for the .....

And hereby declare my intention to tender for the said contract.

Done at .....

Signature of .....  
In the capacity of .....  
Duly authorized to sign the tenders on behalf of  
.....

Annex N° 2: MODEL BID

I the undersigned, ..... (indicate the name and capacity of signatory)  
Representing the ..... company or enterprise or group with head office at  
..... registered in the trade register of ..... Under the number .....

Having taken cognizance of all the documents featured or mentioned in the Tender file: Open National Invitation to Tender No \_\_\_/ONIT/NWRA/ITB/2026 of \_\_/\_\_/2026 FOR THE PHASE II CONSTRUCTION AND COMPLETION OF A THEATRE BLOCK AT NKWEN DISTRICT HOSPITAL after having personally taking account of the situation of the site and evaluated from my point of view and under my responsibility, the nature and difficulty of the works to be carried out;

- Hereby submit, bearing my signature, the schedule of unit prices as well as the quotations in accordance with the structure featuring in the Tender File;
- Submit and commit myself to execute the works in accordance with the Tender File, in return for the prices which I myself establish for each type of structure which prices reveal the amount of the tender at ..... (in figures and words) CFAF exclusive of VAT and at .....( in figures and in words) CFAF inclusive of all taxes.
- I pledge to execute the works within a deadline of ..... months.
- I pledge to maintain my offer for a duration of **Ninety (90)** days from the deadline of submission of tenders;

The Contracting Authority shall pay the sums due for this Contract by crediting Account N°:..... opened in ..... Bank .....Branch.

Prior to the signing of the Contract, this tender accepted by you shall constitute an agreement between us.

Done at .....

Signature of .....  
In the capacity of .....  
Duly authorized to sign the tenders on behalf of  
.....

Annex N° 3: MODEL BID BOND

**Bank:**

**Reference No.** .....

Addressed to the Contracting Authority: The President of the North West Regional Assembly

Whereas the undertaking..... Hereinafter referred to as the “bidder” has submitted his tender on ..... for Open National Invitation to Tender No \_\_\_/ONIT/NWRA/ITB/2026 of \_\_\_/\_\_\_/2026 FOR THE PHASE II CONSTRUCTION AND COMPLETION OF A THEATRE BLOCK AT NKWEN DISTRICT HOSPITAL, hereinafter referred to as “the tender” and to which must be attached a bid bond equivalent to ..... CFAF.

We ..... (name and address of the bank), represented by ..... (names of signatories), hereinafter referred to as “the Bank” hereby declare to guarantee payment to the Contracting Authority of the maximum sum of ....., that the bank pledges to pay in full to the Contracting Authority, bidding itself, its successors and assignees.

The conditions of this commitment are as follows:

If the Bidder withdraws his offer during the validity period specified by the Bidder in the tender; or

If the Bidder, having been notified of the award of the contract by the Contracting Authority during the period of Bid validity:

- Fails or refuses to sign the contract, even though required to do so;
- Fails or refuses to furnish the final bond for the contract (final bond) as provided for by the contract.

We undertake to pay the Contracting Authority an amount up to the maximum of the sum referred to above upon receipt of his first written demand, without the Contracting Authority having to substantiate his demand, provided that in its demand the Contracting Authority shall note that the amount claimed by him is due, because one or the other or both of the above condition(s) has (have) been fulfilled and he shall specify which condition(s) took effect.

This bond shall enter into force from the date of signature and from the date set by the Contracting Authority for the submission of tenders. It shall remain valid up till the thirtieth day inclusive following the end of the deadline for the validity of tenders. Any request by the Contracting Authority to cause it to take effect should reach the bank by registered mail with an acknowledgement of receipt before the end of this period of validity.

This bond shall, for purposes of its interpretation, be submitted to Cameroon law. Cameroon courts shall be the only jurisdictions competent to rule on this commitment and its consequences.

Signed and authenticated by the bank

at ....., on .....

(Bank’s signature

Annex N° 4: MODEL FINAL BOND

Bank: .....  
Reference of the Bond N°: .....

Addressed to The President of the North West Regional Assembly “Contracting Authority”

Whereas ..... (Name and address of Contractor) hereinafter referred to “the Contractor”,  
pledge, in execution of the Contract, to carry out the works: Open National Invitation to Tender N°  
\_\_\_/ONIT/NWRA/ITB/2026 of \_\_/\_\_/2026 FOR THE PHASE II CONSTRUCTION AND  
COMPLETION OF A THEATRE BLOCK AT NKWEN DISTRICT HOSPITAL.

Whereas it is stipulated in the Contract that the Contractor shall furnish the Contracting Authority a final bond  
of two percent (2%) of the amount of the Contract as security for compliance with the Contractor’s  
performance obligations in accordance with the Contract.

Whereas we have agreed to provide the Contractor with this guarantee;  
We, ..... (name and address of bank),  
Represented by ..... (name of signatories)  
hereinafter referred to as “the Bank”, and we pledge to pay to the Contracting Authority within a maximum  
deadline of eight (8) weeks upon his simple written request declaring that the Contractor has not fulfilled his  
contractual obligations, without being able to defer the payment nor raise any contest for whatever reason, the  
sum of..... (in letters and in words).

We hereby agree that no change or addendum or any other amendment shall release us of any obligation  
incumbent on us by virtue of this bond and we hereby derogate by the present to the notification of any  
amendment, addendum or change.

This bond shall enter into force upon signature. It shall be released within thirty (30) days from the date of  
the Provisional Reception of the works.

After this date the caution shall no longer be valid and shall be returned to us without any request on our part.

Any request for payment formulated by the Contracting Authority by virtue of this bond should be done by  
registered mail with acknowledgement of receipt to reach the bank during the period of validity of this  
commitment.

This bond shall, for purposes of its interpretation and execution, be subject to Cameroon law. Cameroon courts  
shall be the only jurisdictions competent to rule on this pledge and its consequences.

Signed and authenticated by the bank at ..... on .....  
[signature of the bank]

Annex N° 5: MODEL OF PERFORMANCE BOND (GUARANTEE RETENTION)

Bank: .....  
Reference of the Bond No: .....

Addressed to: The President of the North West Regional Assembly  
Hereinafter referred to as "The Contracting Authority"

Whereas ..... (name and address of Contractor) hereinafter referred to "the Contractor",  
pledge , in execution of the Contract, to carry out the works **FOR THE PHASE II CONSTRUCTION AND  
COMPLETION OF A THEATRE BLOCK AT NKWEN DISTRICT HOSPITAL**

Whereas it is stipulated in the Contract that the Guarantee Retention fixed at ten percent (10%) of the amount  
of the Contract may be replaced by a joint guarantee;

Whereas we have agreed to provide the Contractor with this guarantee;

We, ..... (name and address of bank),  
Represented by ..... (name of signatories) and hereinafter referred to as "the  
Bank";

Hence, we hereby affirm that on behalf of the Contractor, we guarantee and are responsible to the Contracting  
Authority for a maximum amount of ..... (in figures and in letters) corresponding to ten  
percent (10%) of the Contract amount.

And we pledge to pay to the Contracting Authority within a maximum deadline of eight (8) weeks upon his  
simple written request declaring that the contractor has not fulfilled his contractual obligations or is indebted  
to the Contracting Authority within the meaning of the contract, amended where need be, by its additional  
clauses, without being able to defer the payment nor raise any contest for whatever reason, any sum(s) within  
the limits of the amount equal to ten percent (10%) of the total amount of the works featuring in the final  
detailed account, without the Contracting Authority having to prove or give the reasons nor the motive for the  
amount of the sum indicated above.

We hereby agree that no change or addendum or any other amendment shall release us of any obligation  
incumbent on us by virtue of this bond and we hereby derogate by the present to the notification of any  
amendment, addendum or change.

This bond shall enter into force upon signature. It shall be released within thirty (30) days from the date of  
the final acceptance of the works and upon released issued by the Contracting Authority.

Any request for payment formulated by the Contracting Authority by virtue of this bond should be done by  
registered mail with acknowledgement of receipt to reach the bank during the period of validity of this  
commitment.

This bond shall, for purposes of its interpretation and execution, be subject to Cameroon law. Cameroon courts  
shall be the only jurisdictions competent to rule on this pledge and its consequences.

Signed and authenticated by the bank at ..... on .....  
[signature of the bank]

## ANNEX N° 6: SCHEDULE FRAMEWORK

### Note on the presentation of schedules

The quantities, daily outputs, the duration of execution of works and the slowdowns or even the due interruptions must be clearly brought out in the schedules.

The financial schedules resulting from the schedules of works must indicate month by month, the estimated amounts of the detailed accounts of works by item and cumulatively by taking into account the incidence of rainy seasons for the basic solution and possibly variant solution.

Annex N° 7: MODEL ATTESTATION OF SITE VISIT

LETTER HEAD HERE

TO WHOM IT MAY CONCERN

ATTESTATION OF SITE VISIT

This is to testify that Mr .....  
Manager/Technical Director/Engineer of .....  
Has effectively visited the site for .....  
.....  
..... in view to tender for the said project.

This attestation is issued to serve the purpose for which it is intended for.

Annex N° 8: MODEL SITE VISIT REPORT

I) INTRODUCTION

TENDER N° .....

NAME OF THE ENTERPRISE: .....

DATE: .....

II) COMMENTARY

1- Nature of the project site:

2- Accessibility to the project site:

3- Vegetation:

4- Topography of the site:

III) AVAILABILITY OF SERVICES

IV) AVAILABILITY OF MATERIALS

V) DIFFICULTIES

VI) CONCLUSION

Annex N° 9: MODEL TABLE OF REFERENCE

LIST OF PROJECTS EXECUTED BY THE COMPANY

N°	YEAR	NAME OF THE PROJECT	NAME OF THE PROJECT OWNER AND TELEPHONE NUMBER	CONTRACT AMOUNT	CONTRACT DURATION	DATE OF ACCEPTANCE

DONE ON .....AT .....  
By.....  
SIGNATURE .....

Annex N° 10: MODEL TABLE OF EQUIPMENT

LIST OF EQUIPMENT AND MATERIALS AVAILABLE FOR THE  
(project name) .....

N°	DESIGNATION OF THE EQUIPMENT	DESCRIPTION, MARK	AGE AND STATE	NUMBER AVAILABLE	OWNER OR NOT

DONE ON .....AT .....  
By.....  
SIGNATURE .....

ANNEX No. 6: Framework of schedules

DESIGNATION :					
No	Daily out put	Total quantity	Unit	Duration of activity	
<b>WORKMAN SHIP</b>	Category	No	Daily wage	Days break up	Amount
<b>TOTAL A</b>					
<b>EQUIPMENT/MACHINES</b>	Type	No	Daily rate	Days break up	Amount
<b>TOTAL B</b>					
<b>MATERIAL AND MISCELLANEOUS</b>	Type	Unit	Unit cost	Quantity	Amount
<b>TOTAL C</b>					
<b>D</b>	<b>DIRECT TOTAL COST</b>			A+B+C	
<b>E</b>	<b>GENERAL SITE EXPENSES</b>			Dx%	
<b>F</b>	<b>GENERAL OFFICE EXPENSES</b>			Dx%	
<b>G</b>	<b>NET COST</b>			D+E+F	
<b>H</b>	<b>RISK + BENEFITS</b>			Gx%	
<b>P</b>	<b>TOTAL COST (HT)</b>			G+H	
<b>V</b>	<b>UNIT COST (HT)</b>			P/Q'TY	

**Document N°. 11**  
**PRELIMINARY STUDIES**

## Note on preliminary studies

In accordance with the Public Contracts Code, the Project Owner or Delegated Project Owner must, prior to commencing the procedure to award Contracts or refer to the competent Tenders Board, ensure that draft Tender Files are prepared based on preliminary studies.

These studies must be required during the examination of the Tender File (TF) by the Tenders Board.

The Project Owner is bound to fill the questionnaire in annex 1 accompanied by justifications of the said studies.

### Annex N°. 7: Justification of preliminary studies

1. Attach the preliminary studies.
2. Indicate
  - 2.1. The date studies were carried out;
  - 2.2. The name of the Public or private Project Manager
  - 2.3. References of the Contract, if Private Manager carried it out;
  - 2.4. If maintenance works
    - 2.4.1 Description of the studies;
    - 2.4.2 Attach the outline of the itinerary bringing out readings of degradations as well as the approved programming documents.
  - 2.5 Rehabilitation or new works
    - 2.5.1 Are quantities in the quotations the same as those of the studies?
    - 2.5.2 Description of studies: Draft Preliminary Study, Detailed Preliminary Study;
    - 2.5.3 Attach the said studies.

N.B. For services of less scope, the Project Owner may furnish a justification of calculation of quantities of the Tender File.

- *The chairperson of the Tenders Board may, before taking a decision, seek expert advice on the quality of the studies.*

**Document N°.12**

**LIST OF BANKING ESTABLISHMENTS  
AND FINANCIAL BODIES AUTHORISED  
TO ISSUE BONDS FOR PUBLIC  
CONTRACTS**

## **I- BANK**

1. Afriland First Bank (First bank), B.P 11 834, Yaoundé;
2. Banque Atlantique Cameroun (BACM), B.P. 2 933, Douala;
3. Banque Camerounaise des Petites et Moyennes Entreprises (BC-PME). B.P. 12 962, Yaoundé;
4. Banque Gabonaise pour le Financement International (BGFI BANK), B.P. 600 Douala ;
5. Banque International du Cameroun pour l'Épargne et le Crédit (BICEC) B.P. 1 925, Douala ;
6. Bank Of Africa Cameroun (BOA Cameroun), B.P. 4 593, Douala ;
7. CitiBank Cameroun (CITIGROUP), B.P. 4 571, Douala ;
8. Commercial Bank - Cameroon (CBC), B.P 4 004, Douala;
9. Ecobank Cameroun (ECOBANK), B.P 582, Douala;
10. National Financial Credit Bank (NFC-Bank), B.P. 6 578, Yaoundé ;
11. Société Commerciale de Banques-Cameroun (SCB-Cameroun), B.P 300, Douala ;
12. Société Générale Cameroun (SGC), B.P. 4 042, Douala ;
13. Standard Chartered Bank Cameroon (SCBC) B.P. 1784, Douala ;
14. Union Bank of Cameroon (UBC), B.P. 15 569, Douala;
15. United Bank for Africa (UBA), B.P. 2 088, Douala.
16. crédit communautaire d'afrique-bank (CCA – Bank)

## **II - Insurance companies**

17. Activa Assurances
18. AREA Assurances
19. Atlantique Assurances S.A.
20. Benefical General Insurance S.A.
21. Chanas assurances
22. CPA S.A.
23. NSIA Assurances SA
24. PRO-ASSUR S.A.
25. SAAR S.A.
26. SAHAM Assurances S.A.
27. Zenithe Insurance S.A.

# PLANS



12  
13

FOUNDATION PLAN

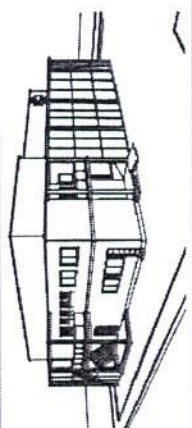
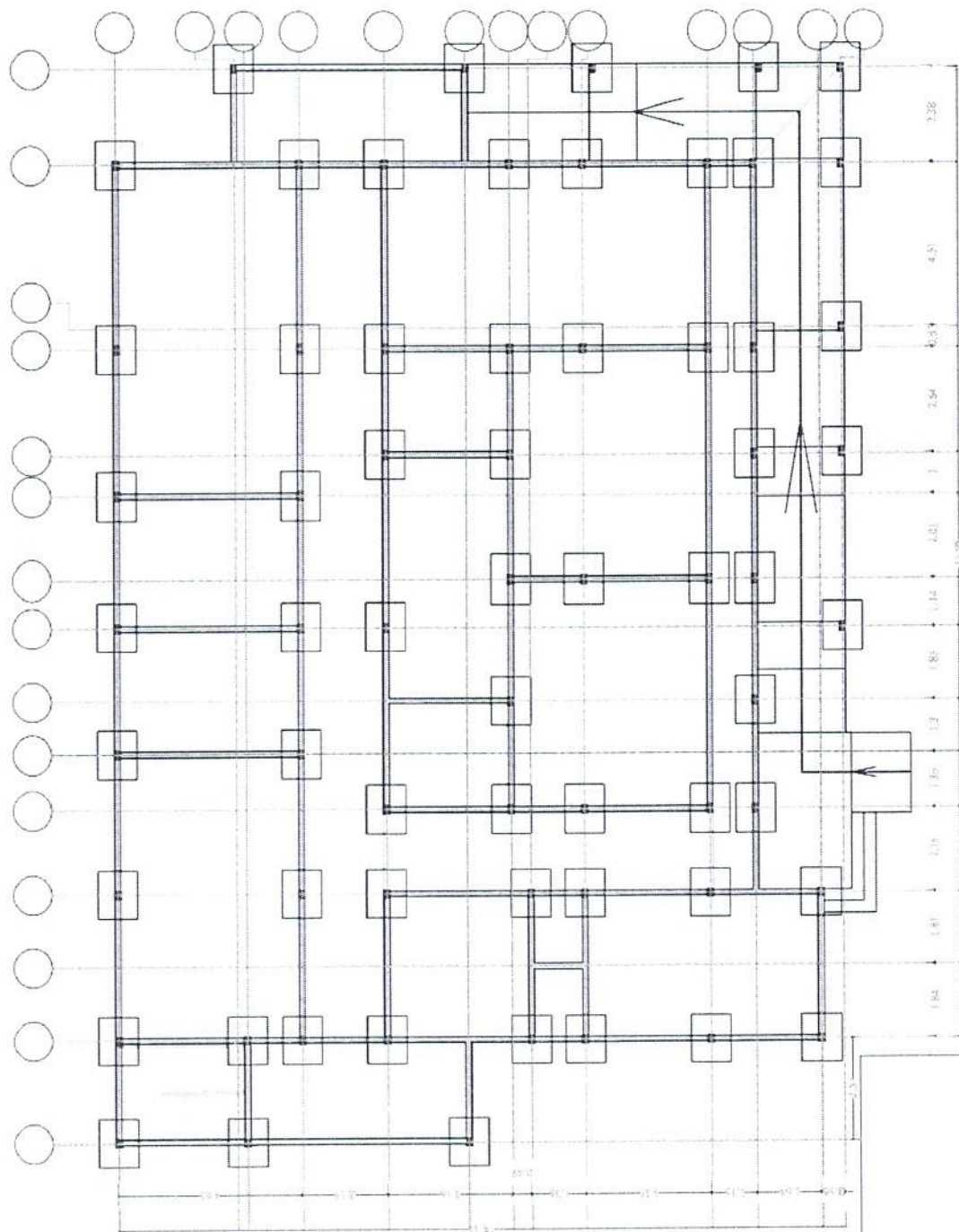



DISTRIBUTION PLAN GROUND FLOOR

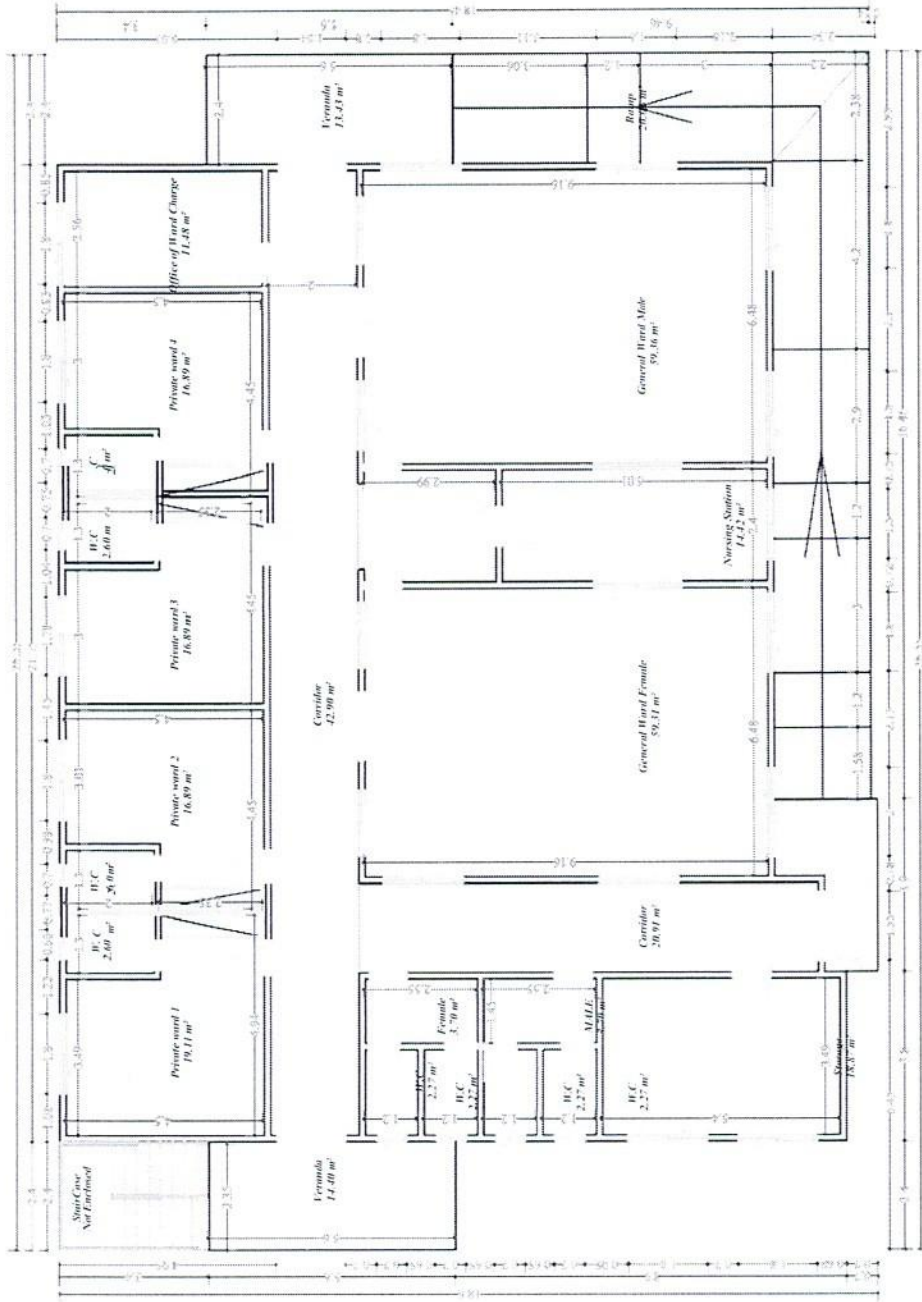

DISTRIBUTION PLAN UPPER FLOOR

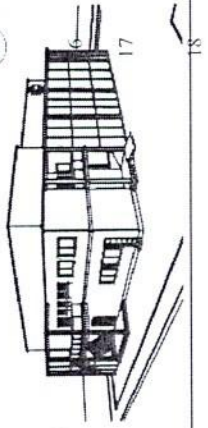
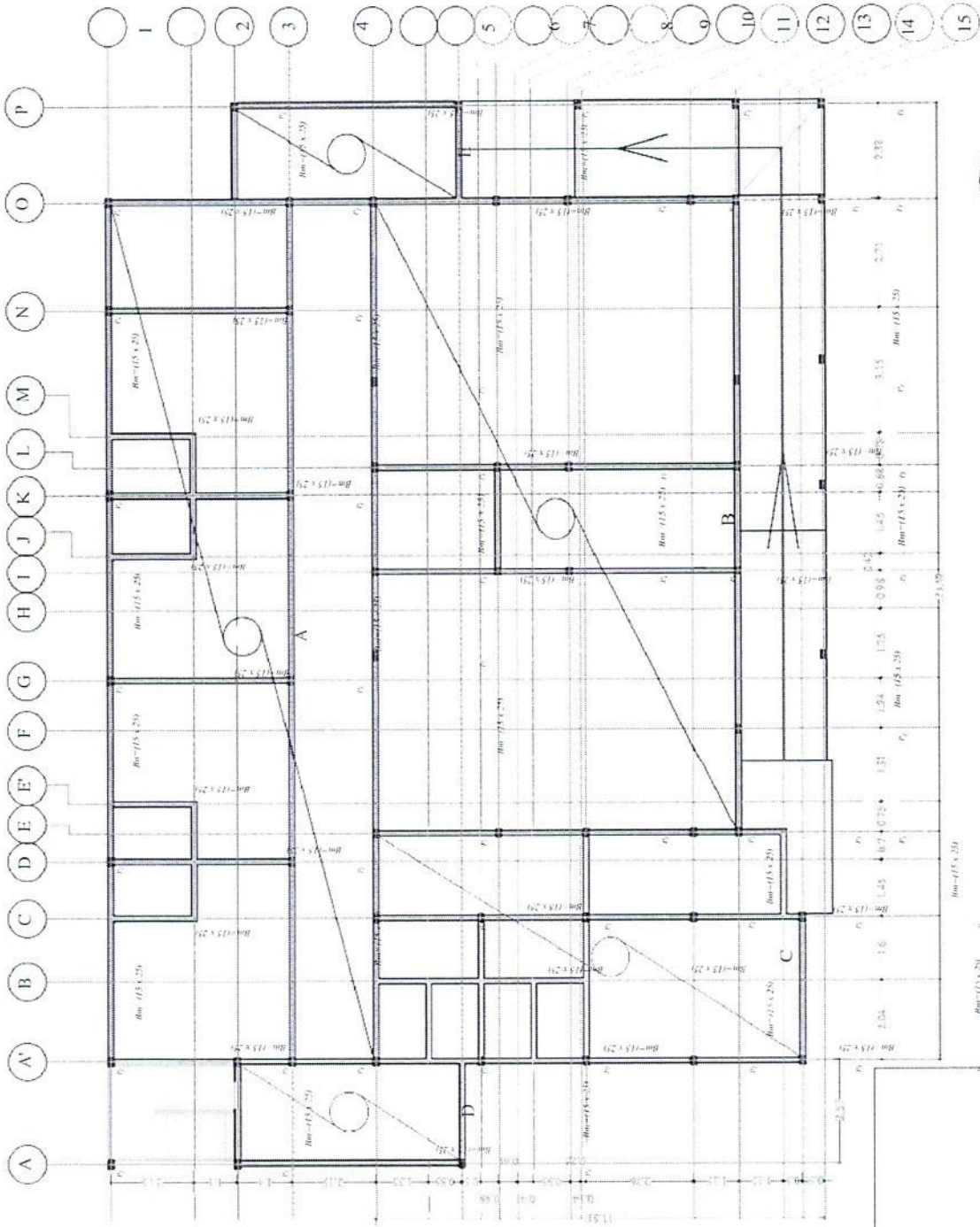

**A3** **ENCLOSURE**

Pillar (P) = 15 X 20  
 Footings (S) = 100 X 120  
 Stairs = 15 X 15

Trench = 45 X 45  
N° of Pillars = 54  
Surface Area = 458.40 m<sup>2</sup>

FORMWORK PLAN

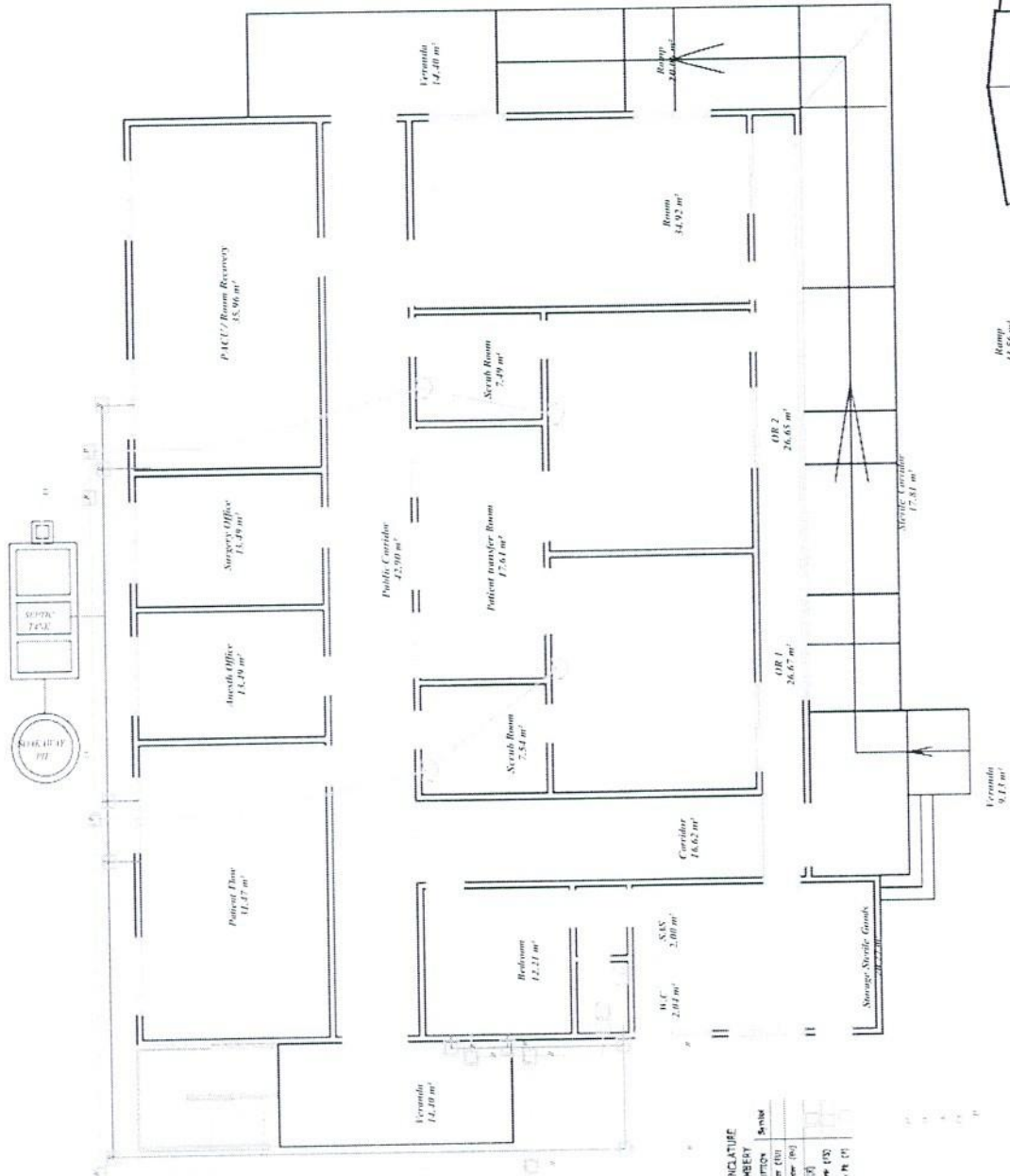

**NOVEMBER 1971**

No.	DESCRIPTION	Area
1	Operating Room	(10)
2	Operating Room	(10)
3	Operating Room	(10)
4	Operating Room	(10)
5	Operating Room	(10)

**A3**

PLOMBERY PLAN GROUND FLOOR



PLOMBERY PLAN UPPER FLOOR

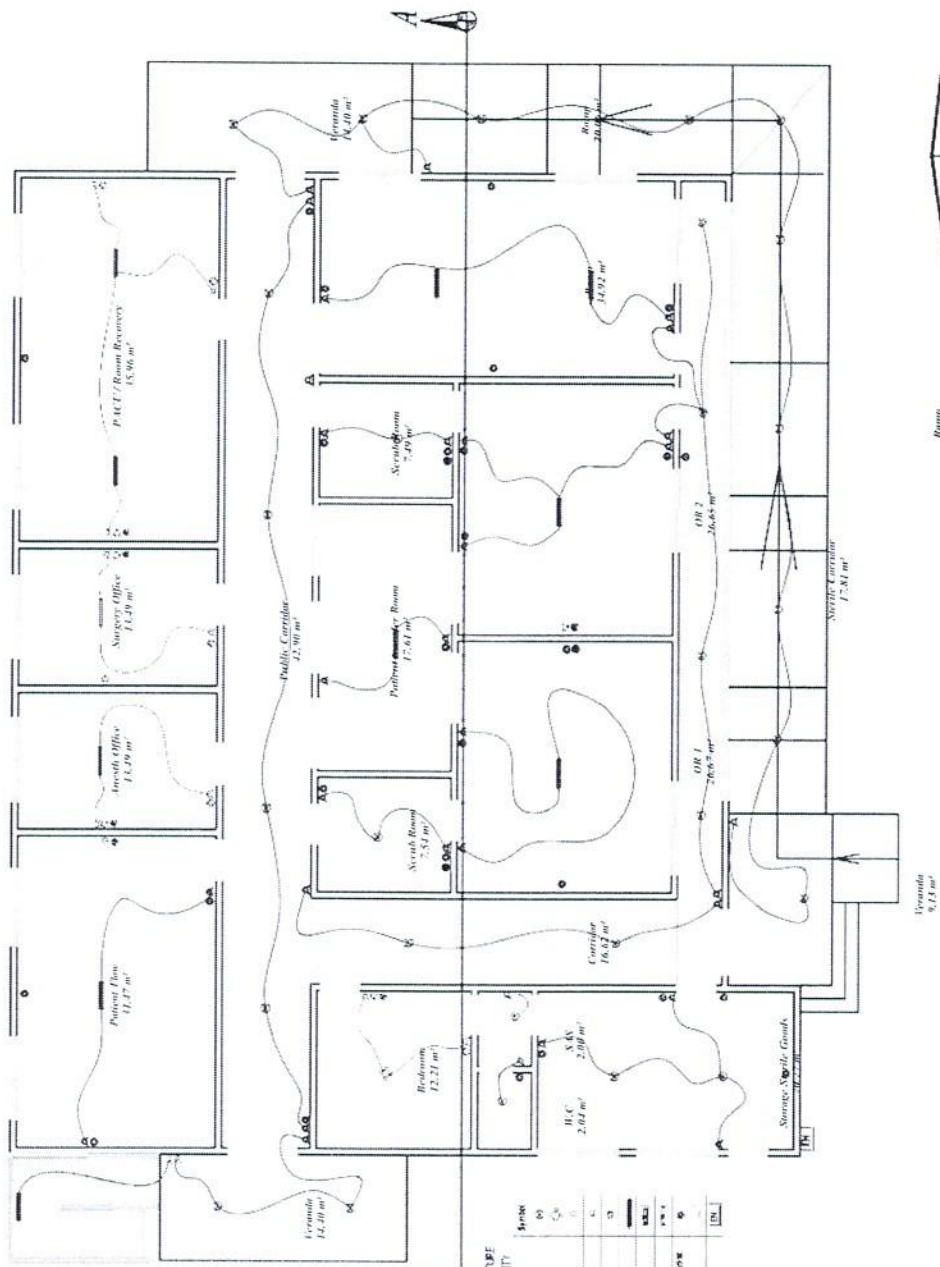

**NON-LOAD BE**

ELECTRICITY		Symbol
01	ADJ. SWCH. (N)	00
02	SWCH. (L)	01
03	SWCH. (S)	02
04	SWCH. (M)	03
05	SWCH. (H)	04
06	SWCH. (L)	05
07	SWCH. (S)	06
08	SWCH. (M)	07
09	SWCH. (H)	08
10	SWCH. (L)	09
11	SWCH. (S)	10
12	SWCH. (M)	11
13	SWCH. (H)	12

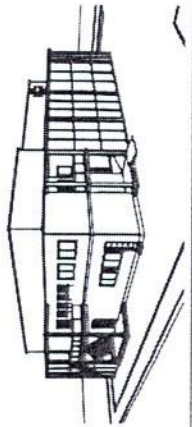

Roof  
13.56 m²

**A3**

ELECTRICAL PLAN GROUND FLOOR

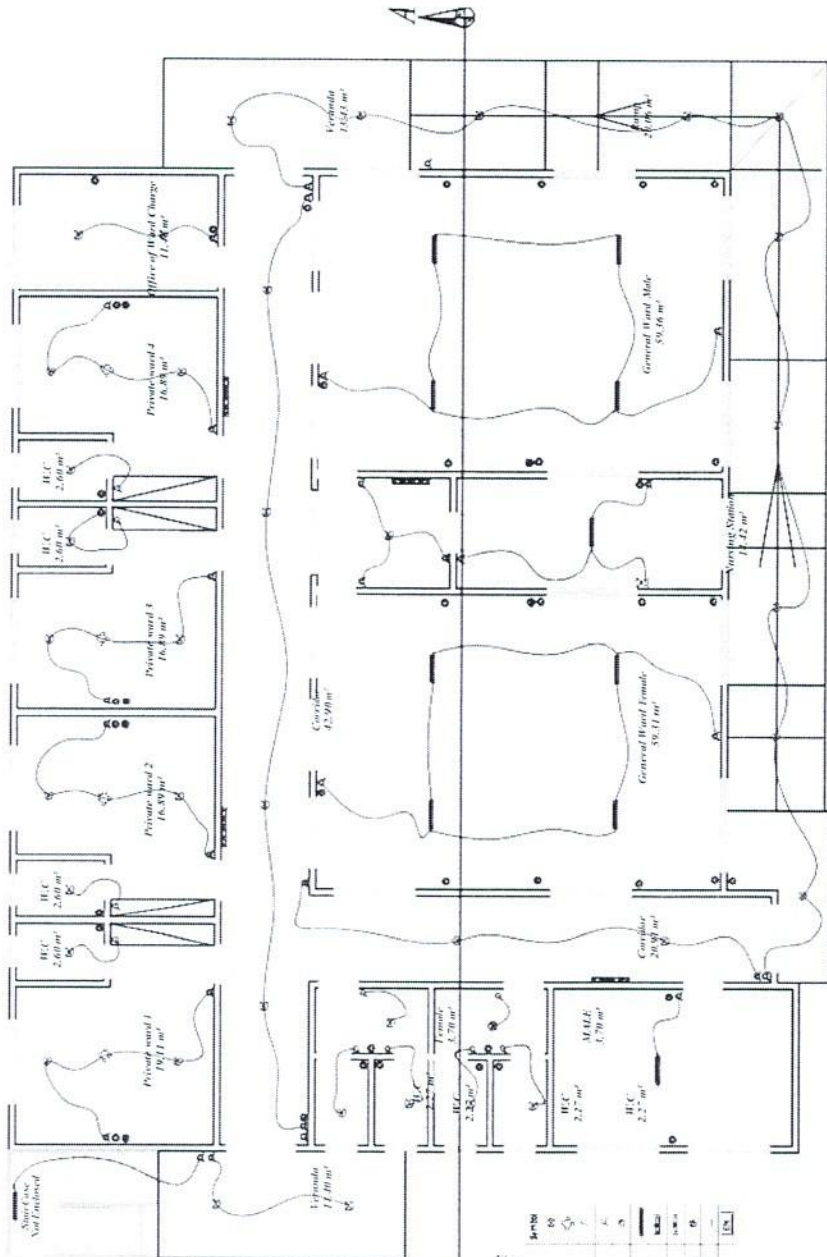

NONIGATURE  
ELECTRICITY

N	DESCRIPTION	sqm
1	ALL ROOMS	16
2	Stair	7
3	Office	11
4	Private ward	16.89
5	H.C.	2.00
6	General ward	36.00
7	General ward	50.11
8	Veranda	13.55
9	Veranda	6.66
10	Storage	16.88
11	Staircase	11.45

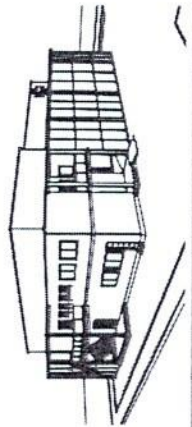

Staircase  
11.45 m<sup>2</sup>

Veranda  
6.66 m<sup>2</sup>

A3

ELECTRICAL PLAN UPPER FLOOR

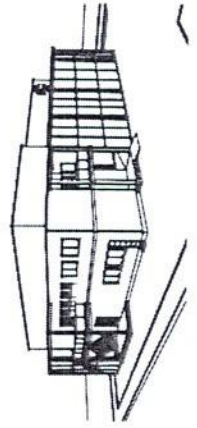
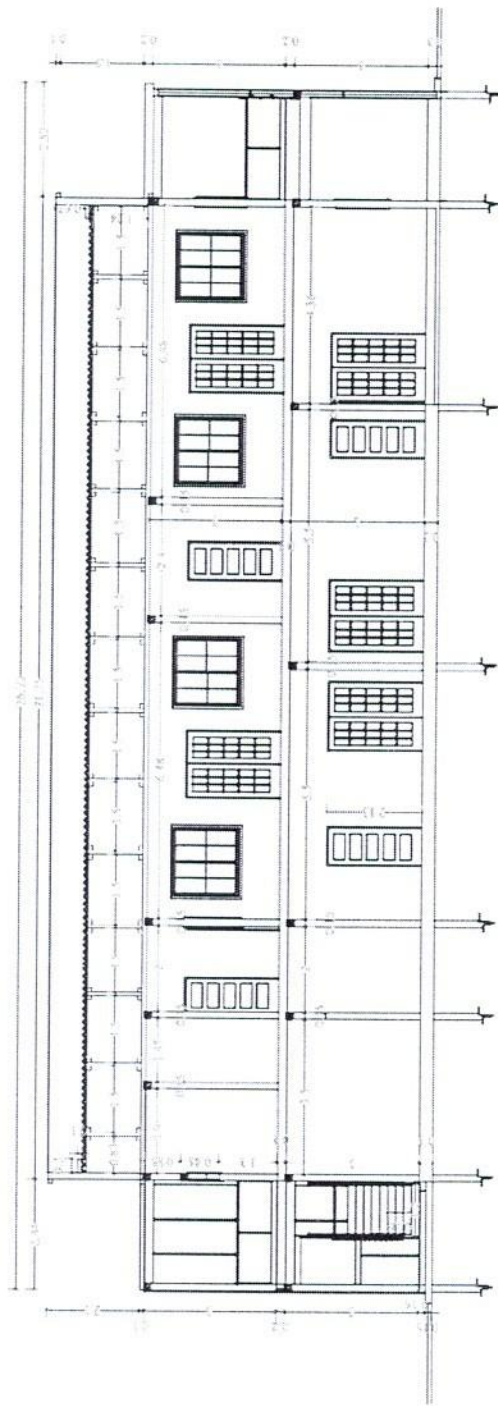

SECTION A-A

A3

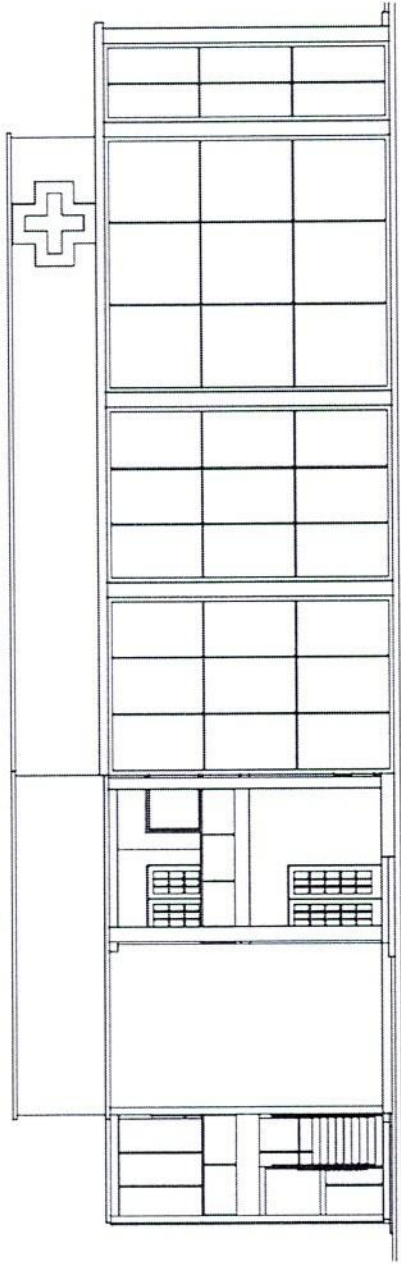

*FRONT ELEVATION*

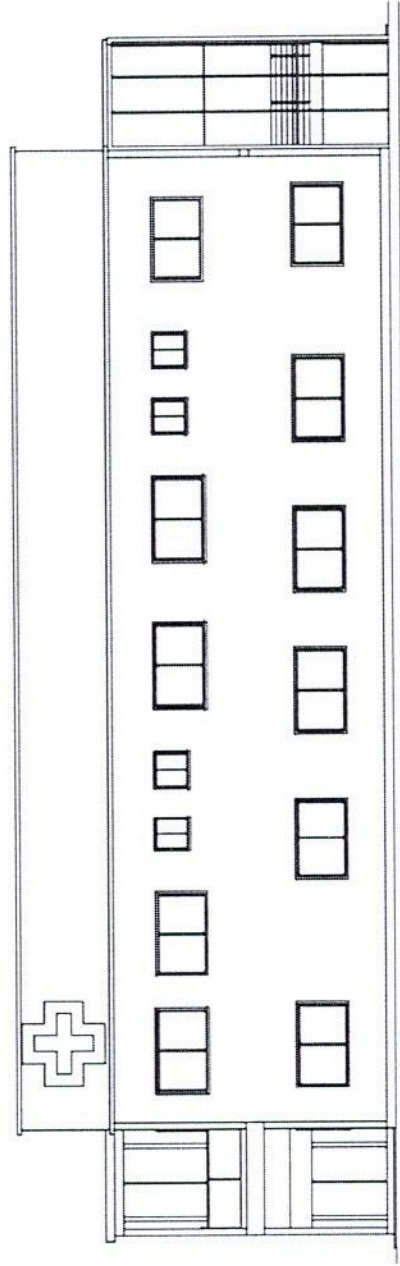

*BACK ELEVATION*

*ELEVATION VIEW*

**A3**

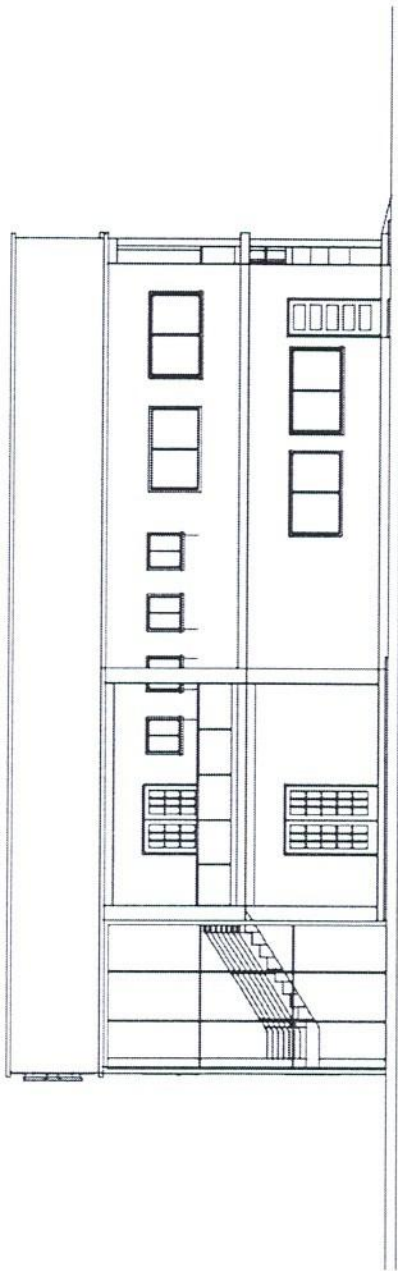

LEFT ELEVATION

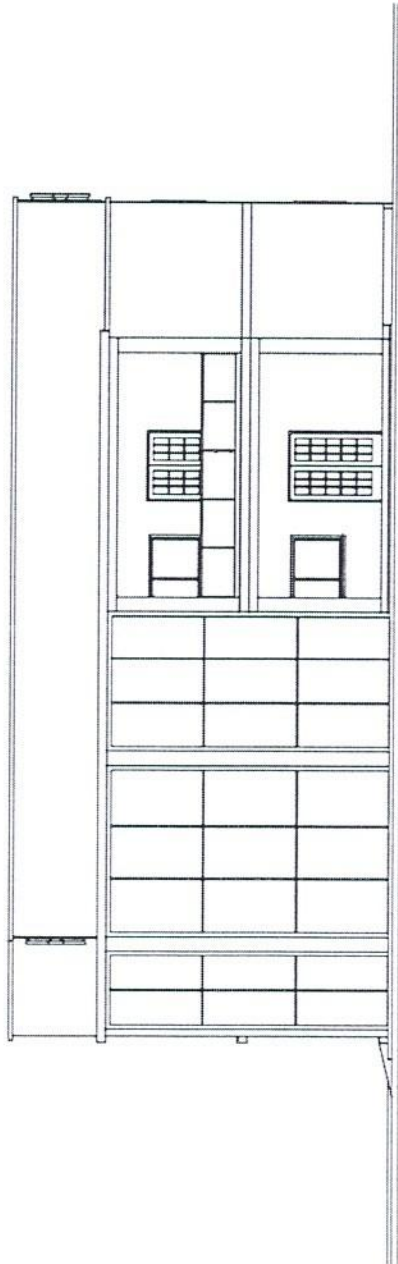

RIGHT ELEVATION

**A3** ELEVATION VIEW

